



# YASKAWA AC Drive High Performance Vector Control A1000

200 V CLASS, 0.4 to 110 kW  
400 V CLASS, 0.4 to 630 kW



The Answer

Certified for  
ISO9001 and  
ISO14001



JQA-0422



JQA-EM0498

# *The Birth of Yaskawa's Ace Drive*

*Offering limitless possibilities....*

A top quality drive: silent, beautiful, and incredibly powerful. Perfectly designed functions open a new field with A1000. A product only possible from Yaskawa, knowing everything there is to know about the world of drive technology to create the most efficient operation possible with an inverter drive. You just have to try it to know how easy it is to use. High level, Yaskawa quality. Integrating the latest vector control technology in a general-purpose drive with the performance of a higher order demanded by the drives industry. A1000 is the answer to user needs, carrying on the Yaskawa traditions of absolute quality in this next generation product line.



The Answer is  
**A1000**

# Contents

Features	4
Features for Every Application	10
Product Lineup	14
Model Selection	15
Software Functions	16
Parameter List	18
Basic Instructions	24
Standard Specifications	26
Standard Connection Diagram	28
Dimensions	30
Fully-Enclosed Design	32
Peripheral Devices and Options	34
Application Notes	58
YASKAWA AC Drive Series	64
Global Service Network	65

The Drive for  
a Greener World

Motor Drive Performance  
Leading the Pack

Transforming the Application Installation  
with Unparalleled Performance.



\* CE and UL approval still pending for some models

# A

# Motor Drive Performance Leading the Pack

## The Most Advanced Drive Technology

- ▲ Capable of driving any kind of motor.  
A1000 runs not only induction motors, but also synchronous motors like IPM and SPM motors with high performance current vector control.
- ▲ Minimize equipment needed for your business by using the same drive to run induction and synchronous motors.
- ▲ Switch easily between motor types with a single parameter setting.

	Induction motor	Synchronous motor (SPM) EMR1 Series	Synchronous motor (IPM) Super Energy-Saving Motor
Features		<ul style="list-style-type: none"> <li>• Ultra-compact, ultra-light</li> <li>• Energy saving, high efficiency</li> <li>• High-performance control without a motor encoder</li> </ul>	<ul style="list-style-type: none"> <li>• Compact, light</li> <li>• Energy saving, high efficiency</li> <li>• High starting torque without an encoder.</li> <li>• Positioning capability without an encoder.</li> </ul>
Capacities		200 V: 0.4 to 7.5 kW	200 V: 0.4 to 75 kW 400 V: 0.4 to 300* kW

\* 160 kW without PG

## Rotor Positioning without Motor Encoder

- ▲ Use an IPM motor to perform position control without motor feedback.  
Electrical saliency in IPM motors makes it possible to detect speed, direction, and rotor position without the use of a motor encoder.
- ▲ Precision positioning functionality without an upper controller.  
Visual programming in DriveWorksEZ lets the user easily create a customized position control sequence, without the use of a motor encoder.

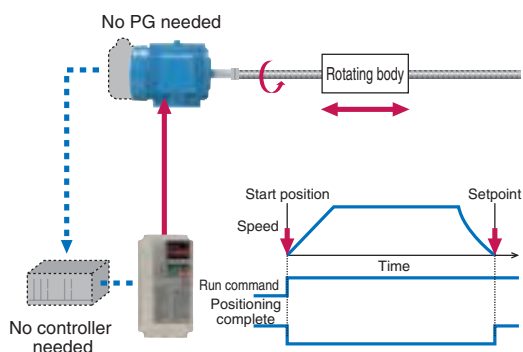

## Cutting-Edge Torque Characteristics

- ▲ Powerful torque at 0 Hz, without a motor encoder\*  
Once out of reach for AC drives, Yaskawa now offers advanced control features without a motor encoder. Achieve even more powerful starting torque at zero speed with an IPM motor.

\* No speed sensors or pole sensors required.



### Synchronous Motor

- Advanced Open Loop Vector Control for PM  
200% rated torque at 0 r/min\*, speed range of 1:100
- Closed Loop Vector Control for PM  
200% rated torque at 0 r/min\*, speed range of 1:1500

\* Achieving this torque output requires a larger capacity drive.

### ● Torque characteristics

[Advanced Open Loop Vector Control for PM with an IPM motor]

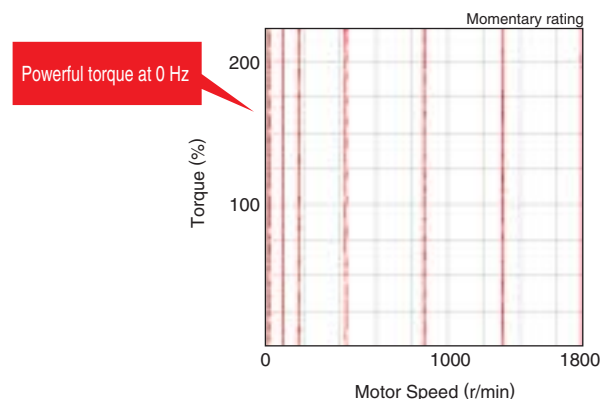

### ● Comparing the speed control range

[Advanced Open Loop Vector Control for PM with an IPM motor]

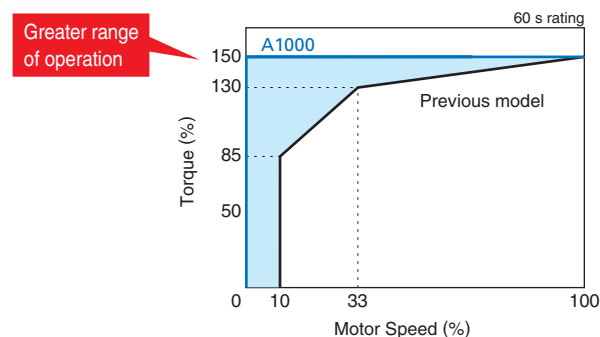

- ▲ High-performance current vector control achieves powerful starting torque with an induction motor.



### Induction Motor

- Open Loop Vector Control  
200% rated torque at 0.3 Hz\*, speed range of 1:200
- Closed Loop Vector Control  
200% rated torque at 0 r/min\*, speed range of 1:1500

\* Achieving this torque output requires a larger capacity drive.

## Loaded with Auto-Tuning Features

- ▲ Auto-Tuning features optimize drive parameters for operation with induction motors as well as synchronous motors to achieve the highest performance levels possible.
- ▲ Perfects not only the drive and motor performance, but also automatically adjusts settings relative to the connected machinery.
  - A variety of ways to automatically optimize drive settings and performance

 Tuning the Motor	
Rotational Auto-Tuning	Applications requiring high starting torque, high speed, and high accuracy.
Stationary Auto-Tuning	Applications where the motor must remain connected to the load during the tuning process.
Line-to-Line Resistance Auto-Tuning	For re-tuning after the cable length between the motor and drive has changed, or when motor and drive capacity ratings differ.
Energy-Saving Auto-Tuning	For running the motor at top efficiency all the time.

 Tuning the Load	
Inertia Tuning	Optimizes the drive's ability to decelerate the load. Useful for applications using KEB and Feed Forward functions.
ASR* Gain Auto-Tuning * Automatic Speed Regulator	Automatically adjusts ASR gain to better match the frequency reference.

Note: This type of Auto-Tuning is available only for motors less than 450 kW using an encoder.

- ▲ Brand-new Auto-Tuning methods. A1000 continuously analyzes changes in motor characteristics during run for highly precise speed control.

## Smooth Operation

- ▲ Smooth low speed operation thanks to even better torque ripple suppression.
  - Comparing torque ripple at zero speed (Closed Loop Vector)

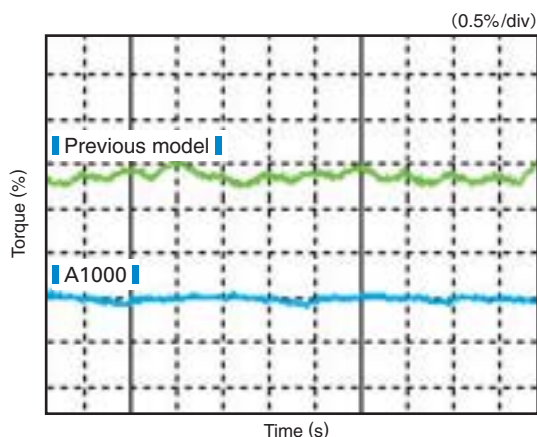

## Tackling Power Loss and Recovery

- ▲ A1000 offers two ways to handle momentary power loss.
- ▲ A1000 is capable of handling momentary power loss for induction motors as well as synchronous motors-- without the use of a motor encoder.

### ● Speed Search

Easily find the speed of a coasting motor for a smooth restart.

#### Applications

Perfect for fans, blowers, and other rotating, fluid-type applications.

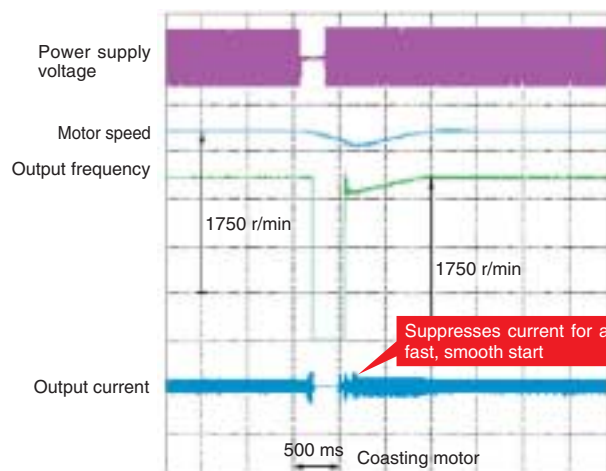

### ● KEB

Keep the motor running without allowing it to coast.

#### Applications

Highly recommended for film lines and other applications requiring continuous operation.



Note: Requires a separate sensor to detect power loss. The drive may trip depending on load conditions, and the motor coast to stop.

- ▲ Ride through power loss for up to 2 seconds.\*
  - Crucial for semi-conductor manufacturers
  - No need to purchase a back-up power supply
  - Detects, outputs an undervoltage signal during power loss

\* The Momentary Power Loss Recovery Unit option may be required depending on the capacity of the drive.



# The Drive for a Greener World

## Energy Saving

### Next-Generation Energy Saving

▲ Loaded with the most advanced energy-saving control technology\*  
Energy Saving control makes highly efficient operation possible with an induction motor.

\* Not available in models 450 kW and above.

▲ Amazing energy saving with a synchronous motor\*  
Combining the high efficiency of a synchronous motor along with A1000's Energy Saving control capabilities allows for unparalleled energy saving.

\* Not available in models 450 kW and above.

#### ● Efficiency using a motor drive

Example shows a 200 V 3.7 kW drive in a fan or pump application.

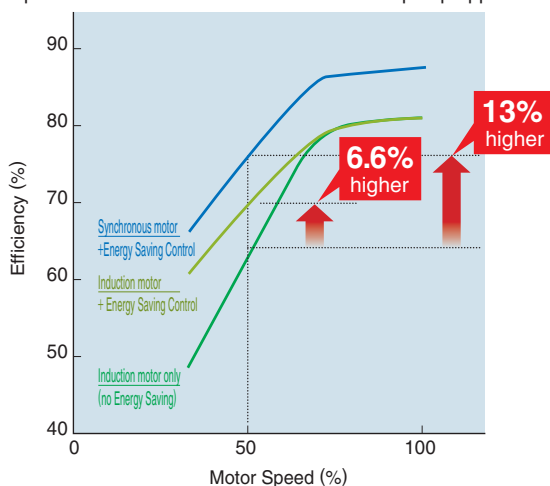

#### ● Examples of energy saving with drives

**Conditions**

**A** : Induction motor + A1000  
**B** : IPM motor + A1000

Annual energy savings for an HVAC fan application running 100 3.7 kW motors. Electric costs of 15 cents/kWH, operating 365 days/year

---

**Annual Energy Savings**

**A** : Induction motor + A1000  
Power consumption: 1,903,100 kWh  
Electrical costs: **\$285,500**

**B** : IPM motor + A1000  
Power consumption: 1,754,600 kWh  
Electrical costs: **\$263,200**

**Total Energy Savings \$22,300**

Annual savings on energy costs: (A) vs. (B)  
Energy saved: 148,500 kWh  
Electrical costs: **\$22,300**

**Annual reduction in CO<sub>2</sub>**  
148,500 kWh × 0.555 ÷ 1,000 = **82.4 tons!**  
Assumes 1 kWh of power consumed creates 0.555 kg/kWH of CO<sub>2</sub>

## Environmental Features

### Protective Design

▲ A variety of protective designs are available to reinforce the drive against moisture, dust, oil mist, vibration, corrosive sulfur gas, conductive particles, and other harsh environments.

▲ IP54 drip-proof and dustproof options are also offered.\*

\* Available soon

### RoHS

▲ All standard products are fully compliant with the EU's RoHS directive.



### Noise Reduction

▲ A1000 uses Yaskawa's Swing PWM function\* to suppress electromagnetic and audible motor noise, creating a more peaceful environment.

\* Not available in models 450 kW and above.

#### ● Comparing our former product line with our new Swing PWM feature

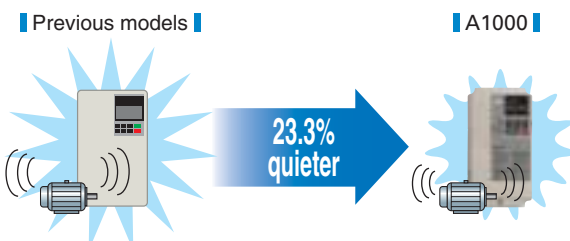

Note: Calculated by comparing peak values during noise generation

### Suppressing Power Supply Harmonics

▲ A DC reactor minimizes harmonic distortion, standard on drives 22 kW and above.

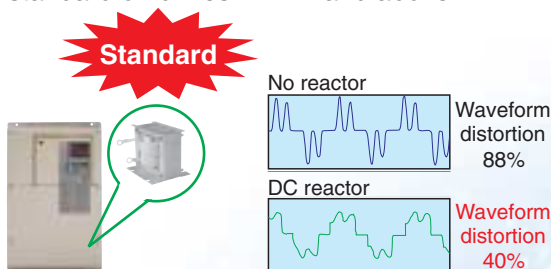

▲ Optional features available soon for compatibility with 12-pulse and 18-pulse rectifiers.\*

\* Requires a separate 3-winding or 4-winding transformer.

▲ Filter option available soon to suppress harmonic distortion.

# Safety

## Safety Regulations

- ▲ All models have a Safe Disable function to stop the motor in accordance with EN954-1 safety category 3, IEC/EN61508 SIL2 requirements.
- ▲ An External Device Monitor (EDM) function has also been added to monitor the safety status of the drive.

● **Safe Disable example: Door switch circuit**

A1000 is equipped with 2 input terminals and a single output terminal for connecting a safe disable device.  
 Input: Triggered when either terminal H1 or H2 opens.  
 Output: EDM output monitors the safety status of the drive.

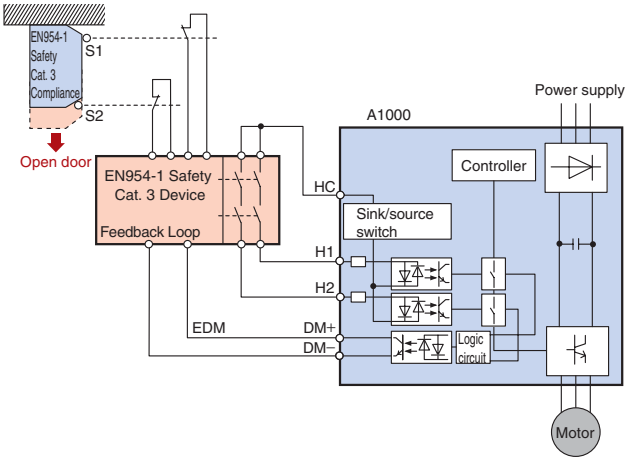

## Controlled Stop Despite Power Loss

- ▲ Should a power outage occur, A1000 can bring the application to controlled stop quickly and safely using the KEB function.\*

\* Under development for models 450 kW and above.

● **Quickly ramp to stop with KEB function**

Applications

Perfect for spindle drive application and film production lines where stopping methods are crucial to the application to reduce production cost.

Previous model

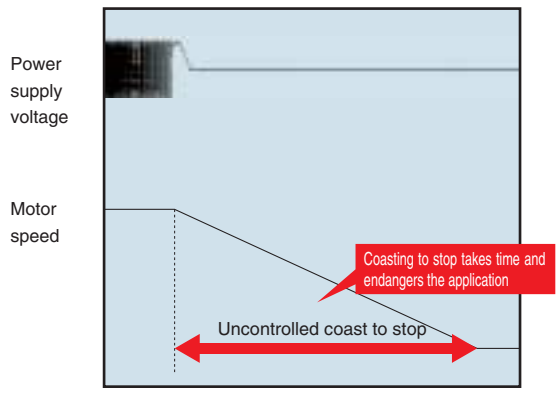

A1000

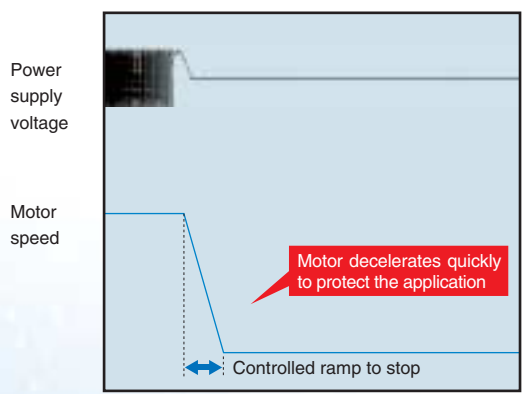

The Answer is  
**A1000**

# A

## Transforming the Application Installation with Unparalleled Performance

### Even More and More Compact

▲ Yaskawa continues to make applications even smaller by combining the world's smallest drive in its class with the light, efficient design of a synchronous motor.

● Comparing drive dimensions

Example: 400 V Class 75 kW

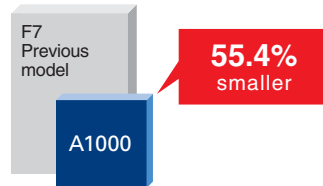

● Comparing motor dimensions

Example: 200 V 3.7 kW motor



▲ Use Side-by-Side installation\* for an even more compact setup. \* For models up to 18.5 kW.

▲ Finless models\* also available. \* For release soon

▲ Dual Rating allows for an even more compact setup. Each drive lets the user choose between Normal Duty or Heavy Duty operation. Depending on the application, A1000 can run a motor an entire frame size larger than our previous model.

● Select the drive rating that best fits the application needs

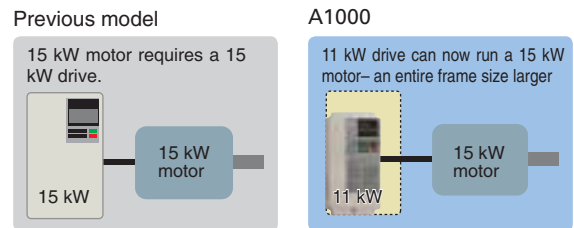

Dual Ratings in A1000

A single parameter lets the user set the drive for Normal Duty or Heavy Duty

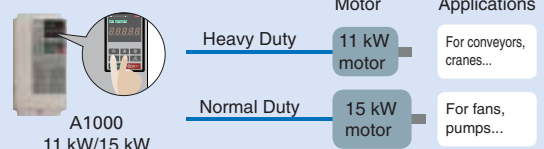

Note: Always select a drive with a current rating greater than the motor rated current.

### Customize Your Drive

▲ DriveWorksEZ visual programming tool with all models

Simply drag and drop icons to completely customize your drive. Create special sequences and detection functions, then load them onto the drive.

● Program a customized sequence

Example: Positioning control without a motor encoder

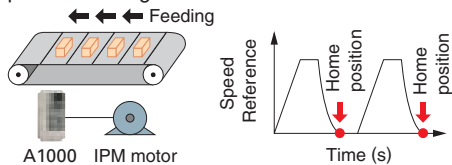

● Create customized detection features

Example: Machine weakening analysis using torque pulse detection

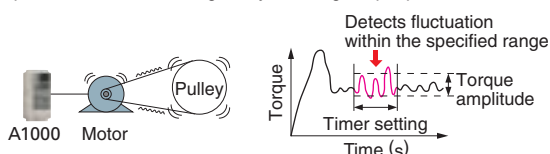

▲ USB for connecting to a PC

● USB port lets the drive connect to a PC



Note: Drives are also equipped with an RJ-45 comm. port that takes the existing WV103 cable used in Yaskawa's previous models. Simply remove the operator keypad for the RJ-45 connector.

### Breeze-Easy Setup

▲ Immediate setup with Application Presets

A1000 automatically sets parameters needed for most major applications. Simply selecting the appropriate application instantly optimizes the drive for top performance, saving enormous time setting up for a trial run.

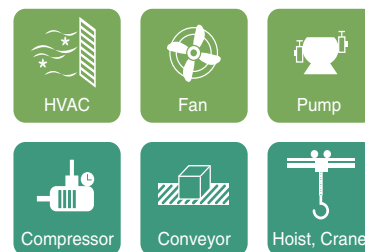

● Example using Application Presets

Selecting "Conveyor" optimizes five parameter settings so the drive is ready to start running your conveyor application immediately.



Setting	Application	Parameters are programmed automatically
00	General-purpose	
01	Water Supply Pump	
02	Conveyor	A1-02 Control mode selection
03	Exhaust Fan	C1-01 Accel Time 1
04	HVAC Fan	C1-02 Decel Time 1
05	Air Compressor	
06	Crane (Hoist)	
07	Crane (Traverse)	C6-01 ND/HD Selection



## Variety of Braking Functions

- ▲ Overexcitation deceleration brings the motor to an immediate stop without the use of a braking resistor.
- ▲ All models up to 30 kW are equipped with a braking transistor for even more powerful braking options by just adding a braking resistor.

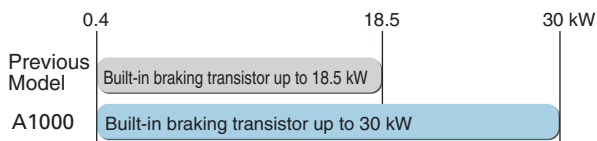

## All Major Serial Network Protocols

- ▲ RS-422/485 (MEMOBUS/Modbus at 115.2 kbps) standard on all models.
- ▲ Option cards available for all major serial networks used across the globe: PROFIBUS-DP, DeviceNet, CC-Link, CANopen, LONWORKS\*, MECHATRO-LINK-II, among others.  
\* Available soon  
Note: Registered trademarks of those companies.
- ▲ Less wiring and space-saving features make for easy installation and maintenance.

## Long Life Performance

### Ten Years of Durable Performance

- ▲ Cooling fan, capacitors, relays, and IGBTs have been carefully selected and designed for a life expectancy up to ten years.\*  
\* Assumes the drive is running continuously for 24 hours a day at 80% load with an ambient temperature of 40°C.

### Motor Life

- ▲ Thanks to relatively low copper loss in the rotor and a cool shaft during operation, synchronous motors have a bearing life twice that of induction motors.

### Performance Life Monitors

- ▲ Yaskawa's latest drive series is equipped with performance life monitors that notify the user of part wear and maintenance periods to prevent problems before they occur.
- Drive outputs a signal to the control device indicating components may need to be replaced

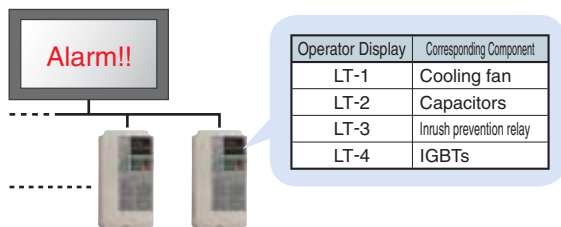

## Easy Maintenance

### The First Terminal Board with a Parameter Backup Function

- ▲ The terminal block's ability to save parameter setting data makes it a breeze to get the application back on-line in the event of a failure requiring drive replacement.

#### ● A1000 Terminal Block

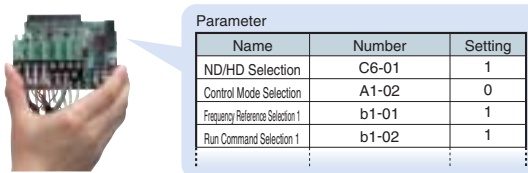

### Engineering Tool DriveWizard Plus

- ▲ Manage the unique settings for all your drives right on your PC.
- ▲ An indispensable tool for drive setup and maintenance. Edit parameters, access all monitors, create customized operation sequences, and observe drive performance with the oscilloscope function.
- ▲ The Drive Replacement feature in DriveWizard Plus saves valuable time during equipment replacement and application upgrades by converting previous Yaskawa product parameter values to the new A1000 parameters automatically.

#### ● Drive Replacement Function

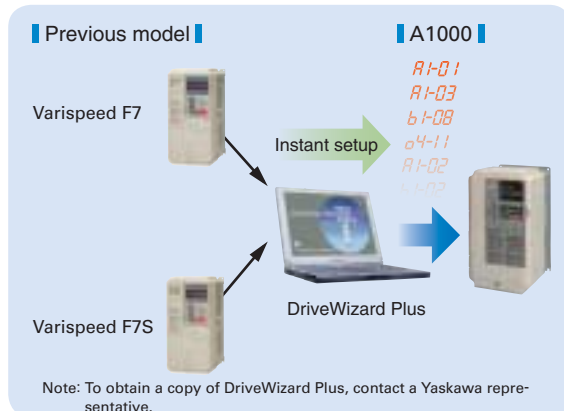

### Parameter Copy Function

- ▲ All standard models are equipped with a Parameter Copy function using the keypad that allows parameter settings to be easily copied from the drive or uploaded for quick setup.
- ▲ A USB Copy Unit is also available as an even faster, more convenient way to back up settings and instantly program the drive.

# Features for Every Application

A1000 is loaded with functions to match the particular needs of every application.



## Cranes

### Advantages

#### 1 Application Presets

Selecting “Crane” from A1000’s Application Presets automatically programs A1000 for optimal performance with a crane application. Save valuable set-up time and start running immediately.

#### 2 Switch Between Motors

Use the same drive to control one motor for hoisting, another motor for traverse operation. Terminal inputs let the user set up a relay to switch back and forth between motors.

#### 3 Powerful Starting Torque

Powerful torque at low speeds ensures the power needed for the application and prevents problems with slipping.

#### 4 Safety Functions

The Safe Disable function comes standard for compliance with various safety regulations.

#### 5 Visual Programming with DriveWorksEZ

Easily customize the drive using a PC.

#### 6 Performance Life Diagnostic Features

A1000 notifies the user or controller when maintenance may be required for certain components such as the cooling fan or capacitors.

#### 7 Terminal Block with Parameter Backup Function



The terminal block can be transferred to a new drive keeping all terminal wiring intact, and built-in memory backs up all parameter settings. An incredible time saver when replacing a drive.

### Functions

<small>NEW</small> Application Presets	Motor 2 Switch	<small>NEW</small> IM/PM Switch
Torque Limit	<small>NEW</small> Overexcitation Braking	<small>NEW</small> Drive WorksEZ
Current Vector Control	Speed Search	Zero Servo Function
<small>NEW</small> Maintenance Monitors	Accel/Decel Time Switch	Torque Detection
KEB Function		

NEW NEW Functions Indicates a new function in A1000

### Applications

	
Hoist, Crane	Shutter Door



Features for Every Application

## Fans and Pumps

Advantages

### 1 Application Presets

Selecting "Fan" or "Pump" from A1000's Application Presets automatically programs A1000 for optimal performance specific for those applications. Save valuable setup time and start running immediately.

### 2 Compact Design

- Yaskawa offers a compact solution for both drive and motor.
- Dual ratings
  - Selecting Normal Duty makes it possible to use a smaller drive.
  - Combine with a synchronous motor
  - Run a synchronous motor instead of an induction motor for an even more compact installation.

### 3 Astounding Efficiency

Combine A1000 with a synchronous motor and save on energy costs.

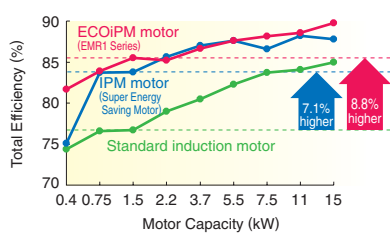

### 4 Output Power Pulse Monitor

Pulse output feature can send a signal to the PLC to keep track of kilowatt hours. No extra power meter needed.  
 Note: Cannot legally be used as proof of power consumption.

### 5 Speed Search

Yaskawa's unique speed search functions easily carry the motor through momentary power loss. No back-up power supply needed to keep the entire application running smoothly.

### 6 24 V Control Power Supply Option

Lets the user monitor drive data from a PLC even when the power goes out.

### 7 Terminal Block with Parameter Backup Function

The terminal block can be transferred to a new drive keeping all terminal wiring intact, and built-in memory backs up all parameter settings. An incredible time saver when replacing a drive.

### 8 Performance Life Diagnostic Features

A1000 notifies the user or controller when maintenance may be required for certain components such as the cooling fan or capacitors.

### 9 Low Harmonic Distortion



DC reactor comes standard on all model above 22 kW to minimize harmonic distortion. This built-in feature saves space and wiring.

### Functions

<small>NEW</small> Application Presets	<small>NEW</small> IM/PM Switch	Momentary Power Loss Ride-Thru
<small>NEW</small> Overexcitation Braking	<small>NEW</small> Watt-Hour Pulse Monitor	Frequency Reference Loss
Accel/Decel Time Switch	Energy Saving	Fault Restart
Speed Search	<small>NEW</small> Drive WorksEZ	Overvoltage Suppression
Frequency Jump	PID Control	<small>NEW</small> Overload Fault Prevention
Frequency Reference Hold	Torque Detection	<small>NEW</small> Maintenance Monitors

NEW Functions Indicates a new function in A1000

### Applications

		
HVAC	Fan	Pump

# Features for Every Application

A1000 is loaded with functions to match the particular needs of every application.



## Metal Working

### Advantages

#### 1 KEB Function

The KEB function can quickly decelerate the motor to stop in case of a power outage, rather than putting equipment at risk by simply allowing the motor to coast. Easy to program to match application needs.

#### 2 Overvoltage Suppression

Particularly beneficial for die cushion and other press-type machinery, overvoltage suppression prevents faults and keeps the application running.

#### 3 Visual Programming with DriveWorksEZ

Easily customize the drive using a PC.

#### 4 Safety Functions

Safe Disable feature comes standard for compliance with various safety regulations.

#### 5 Current Vector Control

Protect connected machinery by controlling torque directly through torque detection and torque limits offered by current vector control.

#### 6 Performance Life Diagnostic Features

A1000 notifies the user or controller when maintenance may be required for certain components such as fan or capacitors.

#### 7 Terminal Block with Parameter Backup Function

The terminal block can be transferred to a new drive keeping all terminal wiring intact, and built-in memory backs up all parameter settings. An incredible time saver when replacing a drive.

### Functions

KEB Function	<b>NEW</b> Overexcitation Braking	Pulse Train Input
Fault Restart	Speed Search	Pulse Train Output
Overvoltage Suppression	Dwell Function	Torque Detection
<b>NEW</b> Overload Fault Prevention	Current Vector Control	Torque Limit
<b>NEW</b> Maintenance Monitors	<b>NEW</b> Drive WorksEZ	Zero Servo Function

**NEW** Functions Indicates a new function in A1000

### Applications



Press



Machine Tool



## Conveyor Systems

Advantages

- 1 Application Presets**  
 Selecting "Conveyor" from A1000's Application Presets presets automatically programs A1000 for optimal performance specific for those applications. Save valuable setup time and start running immediately.
- 2 Safety Functions**  
 Safe Disable feature comes standard for compliance with various safety regulations.
- 3 Astounding Efficiency**  
 Combine A1000 with a synchronous motor to save on energy costs. Save further but still maintain high performance by eliminating the motor encoder.
- 4 Overexcitation Braking**  
 Bring the motor to an immediate stop without the use of a braking resistor (IM motors only).
 

DC voltage

Output frequency

Output current

Normal Deceleration  
Deceleration Time 12.7 s

➔

Overexcitation Deceleration  
Deceleration Time 6.4 s

50% Faster!

Note: Varies in accordance with motor specifications and load.
- 5 Visual Programming with DriveWorksEZ**  
 Easily customize the drive using a PC.
- 6 24 V Control Power Supply Option**  
 Lets the user monitor drive data from a PLC even when the main power is removed.
- 7 Verify Menu**  
 Quickly reference any settings that have been changed from their original default values.
 

Changed Value			
Name	Parameter	Default	Set Value
Frequency Ref. Selection1	b1-01	1	0
Acceleration Time1	C1-01	10.00 s	15.00 s
Deceleration Time1	C1-02	10.00 s	15.00 s
⋮	⋮	⋮	⋮
- 8 Performance Life Diagnostic Features**  
 A1000 notifies the user or controller when maintenance may be required for certain components such as fan or capacitors.
- 9 Low Harmonic Distortion**  
 DC reactor comes standard on all model above 22 kW to minimize harmonic distortion. This built-in feature saves space and wiring.

### Functions

NEW Application Presets

NEW Drive WorksEZ

Current Vector Control

NEW Overexcitation Braking

PID Control

NEW Torque Limit

Droop Control

Pulse Train Input

Zero Servo Function

NEW IM/PM Switch

Pulse Train Output

Fault Restart

NEW Online Tuning

Torque Detection

NEW Maintenance Monitors

NEW Functions Indicates a new function in A1000

### Applications

Conveyor

# Product Lineup

Motor Capacity (kW)	Three-Phase 200 V				Three-Phase 400 V			
	Normal Duty		Heavy Duty		Normal Duty		Heavy Duty	
	Model	Rated Output	Model	Rated Output	Model	Rated Output	Model	Rated Output
0.4			CIMR-AA2A0004	3.2 A			CIMR-AA4A0002	1.8 A
0.75	CIMR-AA2A0004	3.5 A	CIMR-AA2A0006	5 A	CIMR-AA4A0002	2.1 A	CIMR-AA4A0004	3.4 A
1.1	CIMR-AA2A0006	6 A	CIMR-AA2A0008*	6.9 A				
1.5	CIMR-AA2A0008*	8 A	CIMR-AA2A0010	8 A	CIMR-AA4A0004	4.1 A	CIMR-AA4A0005	4.8 A
2.2	CIMR-AA2A0010	9.6 A	CIMR-AA2A0012	11 A	CIMR-AA4A0005	5.4 A	CIMR-AA4A0007	5.5 A
3.0	CIMR-AA2A0012	12 A	CIMR-AA2A0018*	14 A	CIMR-AA4A0007	6.9 A	CIMR-AA4A0009	7.2 A
3.7	CIMR-AA2A0018*	17.5 A	CIMR-AA2A0021	17.5 A	CIMR-AA4A0009	8.8 A	CIMR-AA4A0011	9.2 A
5.5	CIMR-AA2A0021	21 A	CIMR-AA2A0030	25 A	CIMR-AA4A0011	11.1 A	CIMR-AA4A0018	14.8 A
7.5	CIMR-AA2A0030	30 A	CIMR-AA2A0040	33 A	CIMR-AA4A0018	17.5 A	CIMR-AA4A0023	18 A
11	CIMR-AA2A0040	40 A	CIMR-AA2A0056	47 A	CIMR-AA4A0023	23 A	CIMR-AA4A0031	24 A
15	CIMR-AA2A0056	56 A	CIMR-AA2A0069	60 A	CIMR-AA4A0031	31 A	CIMR-AA4A0038	31 A
18.5	CIMR-AA2A0069	69 A	CIMR-AA2A0081	75 A	CIMR-AA4A0038	38 A	CIMR-AA4A0044	39 A
22	CIMR-AA2A0081	81 A	CIMR-AA2A0110	85 A	CIMR-AA4A0044	44 A	CIMR-AA4A0058	45 A
30	CIMR-AA2A0110	110 A	CIMR-AA2A0138	115 A	CIMR-AA4A0058	58 A	CIMR-AA4A0072	60 A
37	CIMR-AA2A0138	138 A	CIMR-AA2A0169	145 A	CIMR-AA4A0072	72 A	CIMR-AA4A0088	75 A
45	CIMR-AA2A0169	169 A	CIMR-AA2A0211	180 A	CIMR-AA4A0088	88 A	CIMR-AA4A0103	91 A
55	CIMR-AA2A0211	211 A	CIMR-AA2A0250	215 A	CIMR-AA4A0103	103 A	CIMR-AA4A0139	112 A
75	CIMR-AA2A0250	250 A	CIMR-AA2A0312	283 A	CIMR-AA4A0139	139 A	CIMR-AA4A0165	150 A
90	CIMR-AA2A0312	312 A	CIMR-AA2A0360	346 A	CIMR-AA4A0165	165 A	CIMR-AA4A0208	180 A
110	CIMR-AA2A0360	360 A	CIMR-AA2A0415	415 A	CIMR-AA4A0208	208 A	CIMR-AA4A0250	216 A
	CIMR-AA2A0415	415 A						
132					CIMR-AA4A0250	250 A	CIMR-AA4A0296	260 A
160					CIMR-AA4A0296	296 A	CIMR-AA4A0362	304 A
185					CIMR-AA4A0362	362 A	CIMR-AA4A0414	370 A
220					CIMR-AA4A0414	414 A	CIMR-AA4A0515	450 A
250					CIMR-AA4A0515	515 A		
315							CIMR-AA4A0675	605 A
355					CIMR-AA4A0675	675 A		
450							CIMR-AA4A0930	810 A
500					CIMR-AA4A0930	930 A		
560							CIMR-AA4A1200	1090A
630					CIMR-AA4A1200	1200 A		

## Model Number Key

\* Available in Japan only

**CIMR- A A 2 A 0004 F A A**

AC Drive    A1000 Series    Customized Specifications    Output Current A    Enclosure Type    Design Revision Order

No.	Region Code	No.	Voltage Class	No.	Customized Specifications	No.	Output Current A	No.	Enclosure Type	No.	Environmental Specifications		
T	Asia	2	3-phase, 200-240 Vac	A	Standard model		Note: See chart above.	A	IP00	A	Standard	N	Oil
A	Japan	4	3-phase, 380-480 Vac					F	NEMA Type1	C	Salt resistant	P	Moisture, dust, vibration
										K	Gas	R	Gas, vibration
										M	Humidity, dust	S	Shock, vibration
												T	Oil, vibration

Note: Contact a Yaskawa representative for more on environmental specifications.

# Model Selection

## Optimizing Control for Each Application

A1000 offers two separate performance ratings: Normal Duty and Heavy Duty.

Heavy Duty is capable of creating more powerful torque, while Normal Duty allows the drive to operate a larger motor.

Difference between load ratings:

	Normal Duty Rating	Heavy Duty Rating
Parameter settings	C6-01=1	C6-01=0 (default)
Overload tolerance	120% for 60 s	150% for 60 s
Carrier frequency	Low carrier frequency (Swing PWM)*	Low carrier frequency

\* Use Swing PWM to quiet undesirable motor noise generated when operating with a low carrier frequency.  
Not available in models 450 kW and above.

### Normal Duty Applications

#### ● Applications



#### ● Selecting a Drive

For a fan application using a 11 kW motor, select CIMR-AA2A0040 and set it for Normal Duty performance (C6-01 = 1).

Model: CIMR-AA2A0040

Normal Duty: 11 kW

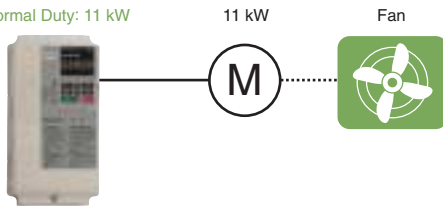

### Heavy Duty Applications

#### ● Applications

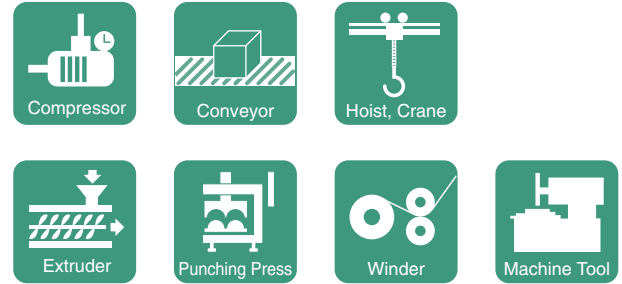

#### ● Selecting a Drive

For a conveyor application using an 11 kW motor, select CIMR-AA2A0056 and set it for Heavy Duty performance (default).

Model: CIMR-AA2A0056

Heavy Duty: 11 kW

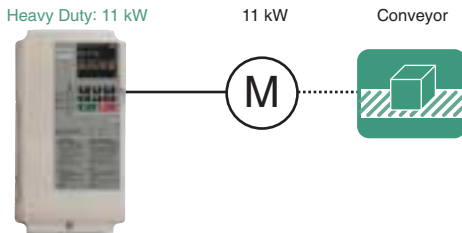

Use the table below to transition from Varispeed F7 and Varispeed F7S to the A1000 series.

Power Supply	200 V			400 V		
	Varispeed F7	Varispeed F7S	A1000	Varispeed F7	Varispeed F7S	A1000
Model	CIMR-F7A2	CIMR-F7S2	CIMR-AA2A	CIMR-F7A4	CIMR-F7S4	CIMR-AA4A
Applicable Motor	Induction Motor	Synchronous Motor	Induction Motor Synchronous Motor	Induction Motor	Synchronous Motor	Induction Motor Synchronous Motor
Max. Applicable Motor Capacity (kW)	0.4	0P4	0P4	0P4	0P4	0002
	0.75	0P7	0P7	0006	0P7	0004
	1.5	1P5	1P5	0010	1P5	0005
	2.2	2P2	2P2	0012	2P2	0007
	3.7	3P7	3P7	0021	3P7	0011
	5.5	5P5	5P5	0030	5P5	0018
	7.5	7P5	7P5	0040	7P5	0023
	11	011	011	0056	011	0031
	15	015	015	0069	015	0038
	18.5	018	018	0081	018	0044
	22	022	022	0110	022	0058
	30	030	030	0138	030	0072
	37	037	037	0169	037	0088
	45	045	045	0211	045	0103
	55	055	055	0250	055	0139
	75	075	075	0312	075	0165
	90	090	-	0360	090	0208
	110	110	-	0415	110	0250
132	-	-	-	132	0296	
160	-	-	-	160	0362	
185	-	-	-	185	0414	
220	-	-	-	220	0515	
315	-	-	-	300	0675	

# Software Functions

Loaded with software functions just right for your application.



New software available to upgrade from F7 to A1000, automatically matching function and sequence settings.

Note: Major functions listed below.



**No need to struggle with difficult parameters and complex calculations.** Parameters are set instantly simply by selecting the appropriate Application Preset.

## Functions at Start and Stop



**Optimal deceleration without needing to set the deceleration time.** Drive slows the application smoothly controlling DC bus voltage.



**Perfect for applications with high load inertia that rarely need to be stopped.** Stop quickly: 50% faster without the use of a braking resistor.

Note: Stopping times may vary based on motor characteristics.

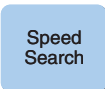

**Start a coasting motor.** Automatically brings a coasting motor back to the target frequency without using a motor encoder.



**Accelerate and decelerate smoothly with large inertia loads.** Drive prevents speed loss by holding the output frequency at a constant level during acceleration and deceleration.

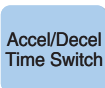

**Switch easily between accel/decel times.** Switch acceleration and deceleration rates when running two motors from the same drive, or assign specific accel/decel rates when operating at high speed or at low speed.

## Reference Functions

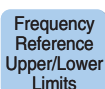

**Limit motor speed.** Set speed limits and eliminate the need for extra peripheral devices and extraneous hardware.



**Skip over troublesome resonant frequencies.** Drive can be programmed to avoid machine resonance problems by avoiding constant speed operation at certain speeds.

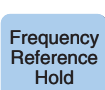

**Improved operability.** Momentarily hold the operating frequency during acceleration or deceleration as the load is lowered or raised.



**Balances the load automatically between motors.** Calculates the ratio of the load torque and adjusts motor speed accordingly.

## Functions for Top Performance



**Run both IM and PM motors with a single drive.** The most advanced motor drive technology can run both IM and PM motors, allowing for even greater energy savings and a more compact setup.



**No extra watt hour meter needed.** A pulse output lets the user monitor power consumption.\*

\* Cannot legally be used as proof of power consumption.

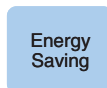

**Automatically runs at top efficiency.\*** The drive supplies voltage to the motor relative to the speed and load so that the application is for operating at the most efficient level.

\* Not available in models 450 kW and above.



**Enables high-precision operation.** Automatically adjusts resistance between motor conductors during operation, thus improving speed accuracy when there are motor temperature fluctuations. This function is active only for Open Loop Vector Control.



**Achieve high levels of performance.** The drive comes with current vector control capabilities for high performance applications.



**Customize the perfect drive to fit your needs.** Upper controller circuitry and drive I/O terminals can be programmed so that extra hardware is no longer needed. Drag-and-drop. Visual programming makes customization a breeze.

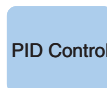

**Automatic PID control.** The internal PID controller fine-tunes the output frequency for precise control of pressure, flow, or other variables.

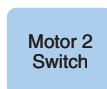

**One drive runs two motors.** Use a single drive to operate two different motors. Only one PM motor may be used.

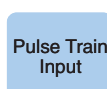

**Improved operability.** Use the Pulse Train Input to control not only the frequency reference, but also PID feedback and PID input.



**Improved monitor functions.** Pulse output lets the user observe everything from the frequency reference and output frequency to motor speed, softstart output frequency, PID feedback, and PID input.



Torque Detection

**Protects the load and helps ensure continuous operation.**  
An output terminal is triggered when motor torque rises above or falls below a specified level. Useful as an interlock signal for protecting equipment when blade problems arise in a machine tool application or for detecting a broken belt.

Limit

**Better reliability: Keep the application running while protecting the load.**  
A1000 helps protect your application by restricting the amount of torque the motor can create.

Torque Control

**Freely adjust torque levels with an external reference signal.**  
Perfect for tension control in winders and assisting torque followers.

Feed Forward Control

**Optimizes speed changes when working with high-inertia loads.**  
Estimates the acceleration/deceleration torque required for the change in speed, and then recalculates the torque reference.

NEW Inertia Tuning

**Automatically optimize ASR settings for superior responsiveness.\***  
Optimizes the drive's ability to decelerate the load. Useful for applications using KEB and Feed Forward functions.  
\* Not available in models 450 kW and above.

Speed Search

**Automatically switches to line power.**  
Switches operation between line power and inverter drive operation without stopping the motor.

Timer Function

**No need for extra hardware.**  
Control timing by opening and closing the output signal relative to the input signal.

Zero Servo Control

**Locks the motor at zero speed.**  
Holds the motor solidly at 0 Hz, regardless of external influences on the load.

NEW Carrier Frequency

**Set the carrier frequency to best match application needs.**  
Reduces noise and resonance in the both the motor as well as the mechanical system. The Swing PWM feature\* can be used to minimize audible motor noise.  
\* Not available in models 450 kW and above.

Continuous Run during Reference Loss

**Keeps the application running.**  
Maintains continuous operation even if the controller fails or frequency reference is lost. An indispensable feature for large HVAC applications.

Fault Restart

**Keep running when a fault occurs.**  
A1000 has full self-diagnostic features and can restart the application in the event of a fault. Up to 10 restarts possible.

## Protective Functions

Momentary Power Loss Ride-Thru

**Keep running even during a momentary loss in power.**  
A1000 automatically restarts the motor and keeps the application going in the event of a power loss.

Overvoltage Suppression

**Avoid overvoltage trip.**  
Effective for punching presses and crank shafts where repetitive motion creates large amounts of regenerative energy. The drive increases or decreases the frequency in correspondence with regen levels to prevent overvoltage from occurring.

NEW Overload Fault Prevention

**Prevents overload faults to keep the application running at all times.**  
Ensures continuous operation during sudden changes in the load that may briefly rise above overload levels and would otherwise shut the application down.

Load Speed Display

**Monitor actual speed of the motor and load.**  
Monitors let the user keep track of motor rotations and line speed.

Copy Function

**Save parameter setting to the digital operator.**  
Copy all parameter settings to the operator keypad, and then transfer those settings to another drive. Saves valuable setup and maintenance time.

NEW Maintenance Monitors

**Notifies the user when maintenance may be required.**  
An output signal is triggered when certain components such as the cooling fan or capacitors are nearing their expected performance life.

KEB Function

**Decelerate to stop when the power goes out.\***  
A1000 uses regenerative energy from the motor to bring the application to a stop, rather than simply letting it coast.  
\* Currently under development for models 450 kW and above.



# Parameter List

Refer to the A1000 Technical Manual for details.

Function	No.	Name	Range	Default	Changes during Run	
Initialization Parameters	A1-00	Language Selection	0 to 7	1*1	○	
	A1-01	Access Level Selection	0 to 2	2*2	○	
	A1-02	Control Method Selection	0,1,2,3,5,6,7	2*1	×	
	A1-03	Initialize Parameters	0 to 5550	0	×	
	A1-04	Password	0 to 9999	0	×	
	A1-05	Password Setting	0 to 9999	0	×	
	A1-06	Application Preset	0 to 7	0	×	
	A1-07	DWEZ Function Selection	0 to 2	0	×	
User Parameters	A2-01 to A2-32	User Parameters, 1 to 32	A1-00 to o4-13	*2	×	
	A2-33	User Parameter Automatic Selection	0, 1	1*2	×	
Operation Mode Selection	b1-01	Frequency Reference Selection 1	0 to 4	1	×	
	b1-02	Run Command Selection 1	0 to 3	1	×	
	b1-03	Stopping Method Selection	0 to 3*3	0	×	
	b1-04	Reverse Operation Selection	0, 1	0	×	
	b1-05	Action Selection below Minimum Output Frequency	0 to 3	0	×	
	b1-06	Digital Input Reading	0, 1	1	×	
	b1-07	LOCAL/REMOTE Run Selection	0, 1	0	×	
	b1-08	Run Command Selection while in Programming Mode	0 to 2	0	×	
	b1-14	Phase Order Selection	0, 1	0	×	
	b1-15	Frequency Reference Selection 2	0 to 4	0	×	
	b1-16	Run Command Selection 2	0 to 3	0	×	
	b1-17	Run Command at Power Up	0, 1	0	×	
	DC Injection Braking and Short Circuit Braking	b2-01	DC Injection Braking Start Frequency	0.0 to 10.0	*3	×
b2-02		DC Injection Braking Current	0 to 100	50%	×	
b2-03		DC Injection Braking Time at Start	0.00 to 10.00	0.00 s	×	
b2-04		DC Injection Braking Time at Stop	0.00 to 10.00	*3	×	
b2-08		Magnetic Flux Compensation Capacity	0 to 1000	0%	×	
b2-12		Short Circuit Brake Time at Start	0.00 to 25.50	0.00 s	×	
b2-13		Short Circuit Brake Time at Stop	0.00 to 25.50	0.50 s	×	
b2-18		Short Circuit Braking Current	0.0 to 200.0	100.0%	×	
Speed Search	b3-01	Speed Search Selection at Start	0, 1	*3	×	
	b3-02	Speed Search Deactivation Current	0 to 200	*3	×	
	b3-03	Speed Search Deceleration Time	0.1 to 10.0	2.0 s	×	
	b3-04	V/f Gain during Speed Search	10 to 100	*4	×	
	b3-05	Speed Search Delay Time	0.0 to 100.0	0.2 s	×	
	b3-06	Output Current 1 during Speed Search	0.0 to 2.0	*4	×	
	b3-10	Speed Search Detection Compensation Gain	1.00 to 1.20	1.05	×	
	b3-14	Bi-Directional Speed Search Selection	0, 1	*3	×	
	b3-17	Speed Search Restart Current Level	0 to 200	150%	×	
	b3-18	Speed Search Restart Detection Time	0.00 to 1.00	0.10 s	×	
Delay Timer	b4-01	Timer Function On-Delay Time	0.0 to 3000.0	0.0 s	×	
	b4-02	Timer Function Off-Delay Time	0.0 to 3000.0	0.0 s	×	
	PID Control	b5-01	PID Function Setting	0 to 4	0	×
		b5-02	Proportional Gain Setting (P)	0.00 to 25.00	1.00	○
		b5-03	Integral Time Setting (I)	0.0 to 360.0	1.0 s	○
		b5-04	Integral Limit Setting	0.0 to 100.0	100.0%	○
		b5-05	Derivative Time (D)	0.00 to 10.00	0.00 s	○
b5-06		PID Output Limit	0.0 to 100.0	100.0%	○	
b5-07		PID Offset Adjustment	-100.0 to 100.0	0.0%	○	
b5-08		PID Primary Delay Time Constant	0.00 to 10.00	0.00 s	○	
b5-09		PID Output Level Selection	0, 1	0	×	
b5-10		PID Output Gain Setting	0.00 to 25.00	1.00	×	
b5-11		PID Output Reverse Selection	0, 1	0	×	
b5-12	PID Feedback Loss Detection Selection	0 to 5	0	×		
b5-13	PID Feedback Low Detection Level	0 to 100	0%	×		
b5-14	PID Feedback Low Detection Time	0.0 to 25.5	1.0 s	×		
b5-15	PID Sleep Function Start Level	0.0 to 400.0	*3	×		
b5-16	PID Sleep Delay Time	0.0 to 25.5	0.0 s	×		
b5-17	PID Accel/Decel Time	0 to 6000.0	0.0 s	×		
b5-18	PID Setpoint Selection	0, 1	0	×		

Note: Footnotes are listed on page 23.

Function	No.	Name	Range	Default	Changes during Run	
PID Control	b5-19	PID Setpoint Value	0.00 to 100.00	0.00%	×	
	b5-20	PID Setpoint Scaling	0 to 3	1	×	
	b5-34	PID Output Lower Limit	-100.0 to 100.0	0.0%	○	
	b5-35	PID Input Limit	0.0 to 1000.0	1000.0%	○	
	b5-36	PID Feedback High Detection Level	0 to 100	100%	×	
	b5-37	PID Feedback High Detection Time	0.0 to 25.5	1.0 s	×	
	b5-38	PID Setpoint User Display	1 to 60000	dep. on	×	
	b5-39	PID Setpoint Display Digits	0 to 3	b5-20	×	
	Dwell Function	b6-01	Dwell Reference at Start	0.0 to 400.0	*3	×
		b6-02	Dwell Time at Start	0.0 to 10.0	0.0 s	×
Droop Control	b6-03	Dwell Frequency at Stop	0.0 to 400.0	*3	×	
	b6-04	Dwell Time at Stop	0.0 to 10.0	0.0 s	×	
	b7-01	Droop Control Gain	0.0 to 100.0	0.0%	○	
Energy Saving	b7-02	Droop Control Delay Time	0.03 to 2.00	0.05 s	○	
	b7-03	Droop Control Limit Selection	0, 1	1	×	
	b8-01	Energy Saving Control Selection	0, 1	*3	×	
	b8-02	Energy Saving Gain	0.0 to 10.0	*3	○	
	b8-03	Energy Saving Control Filter Time Constant	0.00 to 10.00	*2	○	
	b8-04	Energy Saving Coefficient Value	0.00 to 655.00	*4 dep. on E2-11	×	
	b8-05	Power Detection Filter Time	0 to 2000	20 ms	×	
	b8-06	Search Operation Voltage Limit	0 to 100	0%	×	
	b9-01	Zero Servo Gain	0 to 100	5	×	
	b9-02	Zero Servo Completion Width	0 to 16383	10	×	
Acceleration and Deceleration Times	C1-01	Acceleration Time 1	0.0 to 6000.0*2	10.0 s	○	
	C1-02	Deceleration Time 1	0.0 to 6000.0*2	10.0 s	○	
	C1-03	Acceleration Time 2	0.0 to 6000.0*2	10.0 s	○	
	C1-04	Deceleration Time 2	0.0 to 6000.0*2	10.0 s	○	
	C1-05	Acceleration Time 3 (Motor 2 Accel Time 1)	0.0 to 6000.0*2	10.0 s	○	
	C1-06	Deceleration Time 3 (Motor 2 Decel Time 1)	0.0 to 6000.0*2	10.0 s	○	
	C1-07	Acceleration Time 4 (Motor 2 Accel Time 2)	0.0 to 6000.0*2	10.0 s	○	
	C1-08	Deceleration Time 4 (Motor 2 Decel Time 2)	0.0 to 6000.0*2	10.0 s	○	
	C1-09	Fast Stop Time	0.0 to 6000.0*2	10.0 s	×	
	C1-10	Accel/Decel Time Setting Units	0, 1	1	×	
	C1-11	Accel/Decel Time Switching Frequency	0.0 to 400.0	*3	×	
S-Curve Characteristics	C2-01	S-Curve Characteristic at Accel Start	0.00 to 10.00	*3	×	
	C2-02	S-Curve Characteristic at Accel End	0.00 to 10.00	0.20 s	×	
	C2-03	S-Curve Characteristic at Decel Start	0.00 to 10.00	0.20 s	×	
	C2-04	S-Curve Characteristic at Decel End	0.00 to 10.00	0.00 s	×	
	C3-01	Slip Compensation Gain	0.0 to 2.5	*3	○	
	C3-02	Slip Compensation Primary Delay Time	0.0 to 10000	*3	○	
	C3-03	Slip Compensation Limit	0 to 250	200%	×	
Slip Compensation	C3-04	Slip Compensation Selection during Regeneration	0 to 2	0	×	
	C3-05	Output Voltage Limit Operation Selection	0, 1	0	×	
	C3-16	Output Voltage Limit Start (Modulation)	70.0 to 90.0	85.0%	×	
	C3-17	Output Voltage Limit Max (Modulation)	85.0 to 100.0	90.0%	×	
	C3-18	Output Voltage Limit Level	30.0 to 100.0	90.0%	×	
	C3-21	Motor 2 Slip Compensation Gain	0.00 to 2.50	dep. on E3-01	○	
	C3-22	Motor 2 Slip Compensation Primary Delay Time	0 to 10000	dep. on E3-01	○	
	C3-23	Motor 2 Slip Compensation Limit	0 to 250	200%	×	
Torque Compensation	C3-24	Motor 2 Slip Compensation Selection during Regeneration	0 to 2	0	×	
	C4-01	Torque Compensation Gain	0.00 to 2.50	*3	○	
	C4-02	Torque Compensation Primary Delay Time1	0 to 60000	*3 *4	○	
	C4-03	Torque Compensation at Forward Start	0.0 to 200.0	0.0%	×	
	C4-04	Torque Compensation at Reverse Start	-200.0 to 0.0	0.0%	×	
	C4-05	Torque Compensation Time Constant	0 to 200	10 ms	×	
	C4-06	Torque Compensation Primary Delay Time 2	0 to 10000	150 ms	×	
C4-07	Motor 2 Torque Compensation Gain	0.00 to 2.50	1.00	○		



Function	No.	Name	Range	Default	Changes during Run	
Automatic Speed Regulator (ASR)	C5-01	ASR Proportional Gain 1	0.00 to 300.00*3	*3	○	
	C5-02	ASR Integral Time 1	0.000 to 10.000	*3	○	
	C5-03	ASR Proportional Gain 2	0.00 to 300.00*3	*3	○	
	C5-04	ASR Integral Time 2	0.000 to 10.000	*3	○	
	C5-05	ASR Limit	0.0 to 20.0	5.0%	×	
	C5-06	ASR Primary Delay Time Constant	0.000 to 0.500	*3	×	
	C5-07	ASR Gain Switching Frequency	0.0 to 400.0	*3	×	
	C5-08	ASR Integral Limit	0 to 400	400%	×	
	C5-12	Integral Value during Accel/Decel	0, 1	0	×	
	C5-17	Motor Inertia	0.0001 to 600.00	*2 dep. on E5-01	×	
	C5-18	Load Inertia Ratio	0.0 to 6000.0	1.0	×	
	C5-21	Motor 2 ASR Proportional Gain 1	0.00 to 300.00*3	dep. on E3-01	○	
	C5-22	Motor 2 ASR Integral Time 1	0.000 to 10.000	dep. on E3-01	○	
	C5-23	Motor 2 ASR Proportional Gain 2	0.00 to 300.00*3	dep. on E3-01	○	
	C5-24	Motor 2 ASR Integral Time 2	0.000 to 10.000	dep. on E3-01	○	
	C5-25	Motor 2 ASR Limit	0.0 to 20.0	5.0%	×	
	C5-26	Motor 2 ASR Primary Delay Time Constant	0.000 to 0.500	dep. on E3-01	×	
	C5-27	Motor 2 ASR Gain Switching Frequency	0.0 to 400.0	0.0 Hz	×	
	C5-28	Motor 2 ASR Integral Limit	0 to 400	400%	×	
	C5-32	Integral Operation during Accel/Decel for Motor 2	0, 1	0	×	
	C5-37	Motor 2 Inertia	0.0001 to 600.00	*2	×	
	C5-38	Motor 2 Load Inertia Ratio	0.0 to 6000.0	1.0	×	
	Carrier Frequency	C6-01	Drive Duty Selection	0, 1	0	×
		C6-02	Carrier Frequency Selection	1 to F	*2	×
		C6-03	Carrier Frequency Upper Limit	1.0 to 15.0	*2	×
		C6-04	Carrier Frequency Lower Limit	1.0 to 15.0	*2	×
		C6-05	Carrier Frequency Proportional Gain	0 to 99	*2	×
		C6-09	Carrier Frequency during Rotational Auto-Tuning	0, 1	0	×
	Frequency Reference	d1-01	Frequency Reference 1	0.00 to 400.00*2*3	0.00 Hz	○
		d1-02	Frequency Reference 2			○
		d1-03	Frequency Reference 3			○
		d1-04	Frequency Reference 4			○
		d1-05	Frequency Reference 5			○
		d1-06	Frequency Reference 6			○
		d1-07	Frequency Reference 7			○
		d1-08	Frequency Reference 8			○
		d1-09	Frequency Reference 9			○
		d1-10	Frequency Reference 10			○
d1-11		Frequency Reference 11	○			
d1-12		Frequency Reference 12	○			
d1-13		Frequency Reference 13	○			
d1-14		Frequency Reference 14	○			
d1-15		Frequency Reference 15	○			
d1-16		Frequency Reference 16	○			
d1-17		Jog Frequency Reference	0.00 to 400.00*2*3			6.00 Hz
Frequency Upper/Lower Limits	d2-01	Frequency Reference Upper Limit	0.0 to 110.0	100.0%	×	
	d2-02	Frequency Reference Lower Limit	0.0 to 110.0	0.0%	×	
	d2-03	Master Speed Reference Lower Limit	0.0 to 110.0	0.0%	×	

Note: Footnotes are listed on page 23.

Function	No.	Name	Range	Default	Changes during Run
Jump Frequency	d3-01	Jump Frequency 1	0.0 to 400.0	*3	×
	d3-02	Jump Frequency 2			×
	d3-03	Jump Frequency 3			×
	d3-04	Jump Frequency Width			0.0 to 20.0
Frequency Reference Hold and Up/Down 2 Function	d4-01	Freq. Ref. Hold Function Selection	0, 1	0	×
	d4-03	Freq. Ref. Bias Step (Up/Down 2)	0.00 to 99.99	0.00 Hz	○
	d4-04	Freq. Ref. Bias Accel/Decel (Up/Down 2)	0, 1	0	○
	d4-05	Freq. Ref. Bias Operation Mode Selection (Up/Down 2)	0, 1	0	○
	d4-06	Freq. Ref. Bias (Up/Down 2)	-99.9 to 100.0	0.0%	×
	d4-07	Analog Frequency Reference Fluctuation (Up 2/Down 2)	0.1 to 100.0	1.0%	○
	d4-08	Freq. Ref. Bias Upper Limit (Up/Down 2)	0.0 to 100.0	0.0%	○
	d4-09	Freq. Ref. Bias Lower Limit (Up/Down 2)	-99.9 to 0.0	0.0%	○
	d4-10	Up/Down Freq. Ref. Limit Selection	0, 1	0	×
	Torque Control	d5-01	Torque Control Selection	0, 1	0
d5-02		Torque Reference Delay Time	0 to 1000	*3	×
d5-03		Speed Limit Selection	1, 2	1	×
d5-04		Speed Limit	-120 to 120	0%	×
d5-05		Speed Limit Bias	0 to 120	10%	×
d5-06		Speed/Torque Control Switchover Time	0 to 1000	0 ms	×
d5-08		Unidirectional Speed Limit Bias	0, 1	1	×
Field Weakening and Field Forcing		d6-01	Field Weakening Level	0 to 100	80%
	d6-02	Field Weakening Frequency Limit	0.0 to 400.0	0.0 Hz	×
	d6-03	Field Forcing Selection	0, 1	0	×
	d6-06	Field Forcing Limit	100 to 400	400%	×
Offset Frequency	d7-01	Offset Frequency 1	-100.0 to 100.0	0.0%	○
	d7-02	Offset Frequency 2			○
	d7-03	Offset Frequency 3			○
V/f Pattern for motor 1	E1-01	Input Voltage Setting	155 to 255	200 V *5	×
	E1-03	V/f Pattern Selection	0 to F*3	F*1	×
	E1-04	Maximum Output Frequency	40.0 to 400.0*3	*2 dep. on E5-01 for PM motor	×
	E1-05	Maximum Voltage	0.0 to 255.0*5	*2 dep. on E5-01 for PM motor	×
	E1-06	Base Frequency	0.0 to E1-04*3	*2 dep. on E5-01 for PM motor	×
	E1-07	Middle Output Frequency	0.0 to E1-04	*2	×
	E1-08	Middle Output Frequency Voltage	0.0 to 255.0*5	*2	×
	E1-09	Minimum Output Frequency	0.0 to E1-04*5	*2 dep. on E5-01 for PM motor	×
	E1-10	Minimum Output Frequency Voltage	0.0 to 255.0*5	*2	×
	E1-11	Middle Output Frequency 2	0.0 to E1-04*2	0.0 Hz	×
	E1-12	Middle Output Frequency Voltage 2	0.0 to 255.0*2*5	0.0 V	×
	E1-13	Base Voltage	0.0 to 255.0*5	0.0 V*2	×



# Parameter List (continued)

Function	No.	Name	Range	Default	Changes during Run	
Motor 1 Parameters	E2-01	Motor Rated Current	10% to 200% of the drive rated current*2	*2	×	
	E2-02	Motor Rated Slip	0.00 to 20.00	*2	×	
	E2-03	Motor No-Load Current	0 to E2-01*2	*2	×	
	E2-04	Number of Motor Poles	2 to 48	4	×	
	E2-05	Motor Line-to-Line Resistance	0.000 to 65.000	*2	×	
	E2-06	Motor Leakage Inductance	0.0 to 40.0	*2	×	
	E2-07	Motor Iron-Core Saturation Coefficient 1	E2-07 to 0.50	0.50	×	
	E2-08	Motor Iron-Core Saturation Coefficient 2	E2-07 to 0.75	0.75	×	
	E2-09	Motor Mechanical Loss	0.0 to 10.0	0.0%	×	
	E2-10	Motor Iron Loss for Torque Compensation	0 to 65535	*2	×	
	E2-11	Motor Rated Power	0.00 to 650.00	*2	×	
V/f Pattern for Motor 2	E3-01	Motor 2 Control Mode Selection	0 to 3	0	×	
	E3-04	Motor 2 Max. Output Frequency	40.0 to 400.0	dep. on E3-01	×	
	E3-05	Motor 2 Max. Voltage	0.0 to 255.0*5	*5	×	
	E3-06	Motor 2 Base Frequency	0.0 to E3-04	dep. on E3-01	×	
	E3-07	Motor 2 Mid Output Freq.	0.0 to E3-04	dep. on E3-01	×	
	E3-08	Motor 2 Mid Output Freq. Voltage	0.0 to 255.0*5	*5 dep. on E3-01	×	
	E3-09	Motor 2 Min. Output Freq.	0.0 to E3-04	dep. on E3-01	×	
	E3-10	Motor 2 Min. Output Freq. Voltage	0.0 to 255.0*5	*5 dep. on E3-01	×	
	E3-11	Motor 2 Mid Output Frequency 2	0.0 to E3-04*3	0.0*2	×	
	E3-12	Motor 2 Mid Output Frequency Voltage 2	0.0 to 255.0*5	0.0*2	×	
	E3-13	Motor 2 Base Voltage	0.0 to 255.0*5	0.0*2	×	
	Motor 2 Parameters	E4-01	Motor 2 Rated Current	10% to 200% of the drive rated current*2	*2	×
		E4-02	Motor 2 Rated Slip	0.00 to 20.00*2	*2	×
E4-03		Motor 2 Rated No-Load Current	0 to E4-01*2	*2	×	
E4-04		Motor 2 Motor Poles	2 to 48	4	×	
E4-05		Motor 2 Line-to-Line Resistance	0.000 to 65.000	*2	×	
E4-06		Motor 2 Leakage Inductance	0.0 to 40.0	*2	×	
E4-07		Motor 2 Motor Iron-Core Saturation Coefficient 1	0.00 to 0.50	0.50	×	
E4-08		Motor 2 Motor Iron-Core Saturation Coefficient 2	E4-07 to 0.75	0.75	×	
E4-09		Motor 2 Mechanical Loss	0.0 to 10.0	0.0%	×	
E4-10		Motor 2 Iron Loss	0 to 65535	*2	×	
E4-11		Motor 2 Rated Capacity	0.00 to 650.00	*2	×	
PM Motor Settings	E5-01	Motor Code Selection	0000 to FFFF	*2 *1	×	
	E5-02	Motor Rated Capacity	0.10 to 650.00	*1 dep. on E5-01	×	
	E5-03	Motor Rated Current	10% to 200% of the drive rated current*2	*1 dep. on E5-01	×	
	E5-04	Number of Motor Poles	2 to 48	*1 dep. on E5-01	×	

Note: Footnotes are listed on page 23.

Function	No.	Name	Range	Default	Changes during Run
PM Motor Settings	E5-05	Motor Stator Resistance	0.000 to 65.000	*1 dep. on E5-01	×
	E5-06	Motor d-Axis Inductance	0.00 to 300.00	*1 dep. on E5-01	×
	E5-07	Motor q-Axis Inductance	0.00 to 600.00	*1 dep. on E5-01	×
	E5-09	Motor Induction Voltage Constant 1	0.0 to 2000.0	*1 dep. on E5-01	×
	E5-11	Encoder Z Pulse Offset	-180.0 to 180.0	0.0 deg	×
	E5-24	Motor Induction Voltage Constant 2	0.0 to 6500.0	*1 dep. on E5-01	×
	PG Speed Control Card (PG-B3/PG-X3)	F1-01	PG 1 Pulses Per Revolution	0 to 60000	*3
F1-02		Operation Selection at PG Open Circuit (PGo)	0, 1	1	×
F1-03		Operation Selection at Overspeed (oS)	0 to 3	1	×
F1-04		Operation Selection at Deviation	0 to 3	3	×
F1-05		PG 1 Rotation Selection	0, 1	*3	×
F1-06		PG 1 Division Rate for PG Pulse Monitor	1 to 132	1	×
F1-08		Overspeed Detection Level	0 to 120	115%	×
F1-09		Overspeed Detection Delay Time	0.0 to 2.0	*3	×
F1-10		Excessive Speed Deviation Detection Level	0 to 50	10%	×
F1-11		Excessive Speed Deviation Detection Delay Time	0.0 to 10.0	0.5 s	×
F1-12		PG 1 Gear Teeth 1	0 to 1000	0	×
F1-13		PG 1 Gear Teeth 2	0 to 1000	0	×
F1-14		PG Open-Circuit Detection Time	0.0 to 10.0	2.0 s	×
F1-18		dv3 Detection Selection	0 to 10	10	×
F1-19		dv4 Detection Selection	0 to 5000	128	×
F1-20		PG Option Card Disconnect Detection 1	0, 1	1	×
F1-21		PG 1 Signal Selection	0, 1	0	×
F1-30		PG Card Option Port for Motor 2 Selection	0, 1	1	×
F1-31		PG 2 Pulses Per Revolution	0 to 60000	600 ppr	×
F1-32		PG 2 Rotation Selection	0, 1	0	×
F1-33	PG 2 Gear Teeth 1	0 to 1000	0	×	
F1-34	PG 2 Gear Teeth 2	0 to 1000	0	×	
F1-35	PG 2 Division Rate for PG Pulse Monitor	1 to 132	1	×	
F1-36	PG Option Card Disconnect Detection 2	0, 1	1	×	
F1-37	PG 2 Signal Selection	0, 1	0	×	
Analog Input Card (AI-A3)	F2-01	Analog Input Option Card Operation Selection	0, 1	0	×
	F2-02	Analog Input Option Card Gain	-999.9 to 999.9	100.0%	○
	F2-03	Analog Input Option Card Bias	-999.9 to 999.9	0.0%	○
Digital Input Card (DI-A3)	F3-01	Digital Input Option Card Input Selection	0 to 7	0	×
	F3-03	Digital Input Option DI-A3 Data Length Selection	0 to 2	2	×
Analog Monitor Card (AO-A3)	F4-01	Terminal V1 Monitor Selection	000 to 999	102	×
	F4-02	Terminal V1 Monitor Gain	-999.9 to 999.9	100.0%	○
	F4-03	Terminal V2 Monitor Selection	000 to 999	103	×
	F4-04	Terminal V2 Monitor Gain	-999.9 to 999.9	50.0%	○
	F4-05	Terminal V1 Monitor Bias	-999.9 to 999.9	0.0%	○
	F4-06	Terminal V2 Monitor Bias	-999.9 to 999.9	0.0%	○
	F4-07	Terminal V1 Signal Level	0, 1	0	×
	F4-08	Terminal V2 Signal Level	0, 1	0	×
Digital Output Card (DO-A3)	F5-01	Terminal P1-PC Output Selection	0 to 192	0	×
	F5-02	Terminal P2-PC Output Selection	0 to 192	1	×
	F5-03	Terminal P3-PC Output Selection	0 to 192	2	×
	F5-04	Terminal P4-PC Output Selection	0 to 192	4	×
	F5-05	Terminal P5-PC Output Selection	0 to 192	6	×
	F5-06	Terminal P6-PC Output Selection	0 to 192	37	×
	F5-07	Terminal M1-M2 Output Selection	0 to 192	F	×
	F5-08	Terminal M3-M4 Output Selection	0 to 192	F	×
	F5-09	DO-A3 Output Mode Selection	0 to 2	0	×



Function	No.	Name	Range	Default	Changes during Run	
Communication Option Card	F6-01	Communications Error Operation Selection	0 to 3	1	×	
	F6-02	External Fault from Comm. Option Detection Selection	0, 1	0	×	
	F6-03	External Fault from Comm. Option Operation Selection	0 to 3	1	×	
	F6-04	bUS Error Detection Time	0.0 to 5.0	2.0 s	×	
	F6-06	Torque Reference/Torque Limit Selection from Communications Option	0, 1	0	×	
	F6-07	Multi-Step Speed during NetRef/ComRef	0,1	0	×	
	F6-08	Reset Communication Parameters	0,1	0*1	×	
	F6-10	CC-Link Node Address	0 to 64	0	×	
	F6-11	Communication Speed	0 to 4	0	×	
	F6-14	CC-Link bUS Error Auto Reset	0, 1	0	×	
	F6-20	MECHATROLINK-II Node Address	20 to 3FH	21	×	
	F6-21	MECHATROLINK-II Frame Length	0,1	0	×	
	F6-22	MECHATROLINK-II Link Speed	0,1	0	×	
	F6-23	MECHATROLINK-II Monitor Selection (E)	0 to FFFFH	0	×	
	F6-24	MECHATROLINK-II Monitor Selection (F)	0 to FFFFH	0	×	
	F6-25	MECHATROLINK-II WDT Error Selection	0 to 3	1	×	
	F6-26	MECHATROLINK-II bUS Errors	2 to 10	2	×	
	F6-30	PROFIBUS-DP Node Address	0 to 125	0	×	
	F6-31	PROFIBUS-DP Clear Mode Selection	0, 1	0	×	
	F6-32	PROFIBUS-DP Data Format Selection	0, 1	0	×	
	F6-35	CANopen Node ID Selection	0 to 126	0	×	
	F6-36	CANopen Communication Speed	0 to 8	6	×	
	F6-50 to F6-63	DeviceNet Parameters	—	—	×	
	F6-64 to F6-71	Reserved	—	—	×	
	Multi-Function Digital Inputs	H1-01	Multi-Function Digital Input Terminal S1 Function Selection	1 to 9F	40 (F)*6	×
		H1-02	Multi-Function Digital Input Terminal S2 Function Selection	1 to 9F	41 (F)*6	×
		H1-03	Multi-Function Digital Input Terminal S3 Function Selection	1 to 9F	24	×
		H1-04	Multi-Function Digital Input Terminal S4 Function Selection	1 to 9F	14	×
		H1-05	Multi-Function Digital Input Terminal S5 Function Selection	1 to 9F	3 (0)*6	×
		H1-06	Multi-Function Digital Input Terminal S6 Function Selection	1 to 9F	4 (3)*6	×
		H1-07	Multi-Function Digital Input Terminal S7 Function Selection	1 to 9F	6 (4)*6	×
		H1-08	Multi-Function Digital Input Terminal S8 Function Selection	1 to 9F	8	×
	Multi-Function Digital Outputs	H2-01	Terminals M1-M2 Function Selection (relays)	0 to 192	0	×
		H2-02	Terminal P1-PC Function Selection (photocoupler)	0 to 192	1	×
		H2-03	Terminal P2-PC Function Selection (photocoupler)	0 to 192	2	×
		H2-06	Watt Hour Output Unit Selection	0 to 4	0	×
Multi-Function Analog Inputs	H3-01	Terminal A1 Signal Level Selection	0, 1	0	×	
	H3-02	Terminal A1 Function Selection	0 to 31	0	×	
	H3-03	Terminal A1 Gain Setting	-999.9 to 999.9	100.0%	○	
	H3-04	Terminal A1 Bias Setting	-999.9 to 999.9	0.0%	○	
	H3-05	Terminal A3 Signal Level Selection	0, 1	0	×	
	H3-06	Terminal A3 Function Selection	0 to 31	2	×	
	H3-07	Terminal A3 Gain Setting	-999.9 to 999.9	100.0%	○	
	H3-08	Terminal A3 Bias Setting	-999.9 to 999.9	0.0%	○	
	H3-09	Terminal A2 Signal Level Selection	0 to 3	2	×	
	H3-10	Terminal A2 Function Selection	0 to 31	0	×	
	H3-11	Terminal A2 Gain Setting	-999.9 to 999.9	100.0%	○	
H3-12	Terminal A2 Bias Setting	-999.9 to 999.9	0.0%	○		
H3-13	Analog Input Filter Time Constant	0.00 to 2.00	0.03 s	×		

Note: Footnotes are listed on page 23.

Function	No.	Name	Range	Default	Changes during Run
Multi-Function Analog Inputs	H3-14	Analog Input Terminal Enable Selection	1 to 7	7	×
	H3-16	Multi-Function Analog Input Terminal A1 Offset	-500 ~ 500	0	×
	H3-17	Multi-Function Analog Input Terminal A2 Offset	-500 ~ 500	0	×
	H3-18	Multi-Function Analog Input Terminal A3 Offset	-500 ~ 500	0	×
Multifunction Analog Outputs	H4-01	Multi-Function Analog Output Terminal FM Monitor Selection	000 to 999	102	×
	H4-02	Multi-Function Analog Output Terminal FM Gain	-999.9 to 999.9	100.0%	○
	H4-03	Multi-Function Analog Output Terminal FM Bias	-999.9 to 999.9	0.0%	○
	H4-04	Multi-Function Analog Output Terminal AM Monitor Selection	000 to 999	103	×
	H4-05	Multi-Function Analog Output Terminal AM Gain	-999.9 to 999.9	50.0%	○
	H4-06	Multi-Function Analog Output Terminal AM Bias	-999.9 to 999.9	0.0%	○
	H4-07	Multi-Function Analog Output Terminal FM Signal Level Selection	0, 1	0	×
	H4-08	Multi-Function Analog Output Terminal AM Signal Level Selection	0, 1	0	×
MEMOBUS/Modbus Serial Communication	H5-01	Drive Node Address	0 to FFH	1F	×
	H5-02	Communication Speed Selection	0 to 8	3	×
	H5-03	Communication Parity Selection	0 to 2	0	×
	H5-04	Stopping Method After Communication Error (CE)	0 to 3	0	×
	H5-05	Communication Fault Detection Selection	0, 1	0	×
	H5-06	Drive Transmit Wait Time	5 to 65	5 ms	×
	H5-07	RTS Control Selection	0, 1	1	×
	H5-09	CE Detection Time	0.0 to 10.0	2.0 s	×
	H5-10	Unit Selection for MEMOBUS/Modbus Register 0025H	0, 1	0	×
	H5-11	Communications ENTER Function Selection	0, 1	0	×
	H5-12	Run Command Method Selection	0, 1	0	×
	Pulse Train Input/Output	H6-01	Pulse Train Input Terminal RP Function Selection	0 to 3	0
H6-02		Pulse Train Input Scaling	1000 to 32000	1440 Hz	○
H6-03		Pulse Train Input Gain	0.0 to 1000.0	100.0%	○
H6-04		Pulse Train Input Bias	-100.0 to 100.0	0.0%	○
H6-05		Pulse Train Input Filter Time	0.00 to 2.00	0.10 s	○
H6-06		Pulse Train Monitor Selection	000 to 809	102	○
H6-07		Pulse Train Monitor Scaling	0 to 32000	1440 Hz	○
H6-08		Pulse Train Input Minimum Frequency	0.1 to 1000.0	0.5 Hz	×
Motor Protection	L1-01	Motor Overload Protection Selection	0 to 6	*3	×
	L1-02	Motor Overload Protection Time	0.1 to 5.0	1.0 min.	×
	L1-03	Motor Overheat Alarm Operation Selection (PTC input)	0 to 3	3	×
	L1-04	Motor Overheat Fault Operation Selection (PTC input)	0 to 2	1	×
	L1-05	Motor Temperature Input Filter Time (PTC input)	0.00 to 10.00	0.20 s	×
	L1-13	Continuous Electrothermal Operation Selection	0, 1	1	×
	L1-15	Motor 1 Thermistor Selection (NTC)	0, 1	0	×
	L1-16	Motor 1 Overheat Temperature	50 to 200	120	×
	L1-17	Motor 2 Thermistor Selection (NTC)	0, 1	0	×
	L1-18	Motor 2 Overheat Temperature	50 to 200	120	×
	L1-19	Thermistor Phase Loss Operation	0 to 3	3	×
	L1-20	Motor Overheat Operation	0 to 3	1	×



# Parameter List (continued)

Function	No.	Name	Range	Default	Online Changing
Momentary Power Loss Ride-Thru	L2-01	Momentary Power Loss Operation Selection	0 to 5	0	×
	L2-02	Momentary Power Loss Ride-Thru Time	0.0 to 25.5	*2	×
	L2-03	Momentary Power Loss Minimum Baseblock Time	0.1 to 5.0	*2	×
	L2-04	Momentary Power Loss Voltage Recovery Ramp Time	0.0 to 5.0	*2	×
	L2-05	Undervoltage Detection Level (Uv)	150 to 210*5	*5 dep. on E1-01	×
	L2-06	KEB Deceleration Time	0.00 to 6000.00*2	0.00 s	×
	L2-07	KEB Acceleration Time	0.00 to 6000.00*2	0.00 s	×
	L2-08	Frequency Gain at KEB Start	0 to 300	100%	×
	L2-10	KEB Detection Time	0 to 2000	50 ms	×
	L2-11	DC Bus Voltage Setpoint during KEB	150 to 400*5	*5 dep. on E1-01	×
L2-29	KEB Method Selection	0 to 3	0	×	
Stall Prevention	L3-01	Stall Prevention Selection during Acceleration	0 to 2	1	×
	L3-02	Stall Prevention Level during Acceleration	0 to 150*2	*2	×
	L3-03	Stall Prevention Limit during Acceleration	0 to 100	50%	×
	L3-04	Stall Prevention Selection during Deceleration	0 to 5*3	1	×
	L3-05	Stall Prevention Selection during Run	0 to 2	1	×
	L3-06	Stall Prevention Level during Run	30 to 150*2	*2	×
	L3-11	Overvoltage Suppression Function Selection	0, 1	0	×
	L3-17	Target DC Bus Voltage for Overvoltage Suppression and Stall Prevention	150 to 400*5	370 Vdc*5 dep. on E1-01	×
	L3-20	DC Bus Voltage Adjustment Gain	0.00 to 5.00	*3	×
	L3-21	Accel/Decel Rate Calculation Gain	0.10 to 10.00	*3	×
L3-22	Deceleration Time at Stall Prevention during Acceleration	0.0 to 6000.0	0.0 s	×	
L3-23	Automatic Reduction Selection for Stall Prevention during Run	0, 1	0	×	
L3-24	Motor Acceleration Time for Inertia Calculations	0.001 to 10.000	*2 dep. on E2-11 dep. on E5-01	×	
L3-25	Load Inertia Ratio	0.0 to 1000.0	1.0	×	
L3-26	Additional DC Bus Capacitors	0 to 65000	0 $\mu$ F	×	
L3-27	Stall Prevention Detection Time	0 to 5000	50 ms	×	
Speed Detection	L4-01	Speed Agreement Detection Level	0.0 to 400.0	*3	×
	L4-02	Speed Agreement Detection Width	0.0 to 20.0	*3	×
	L4-03	Speed Agreement Detection Level (+/-)	-400.0 to 400.0	*3	×
	L4-04	Speed Agreement Detection Width (+/-)	0.0 to 20.0	*3	×
	L4-05	Frequency Reference Loss Detection Selection	0, 1	0	×
	L4-06	Frequency Reference at Reference Loss	0.0 to 100.0	80.0%	×
	L4-07	Speed Agreement Detection Selection	0, 1	0	×
Fault Reset	L5-01	Number of Auto Restart Attempts	0 to 10	0	×
	L5-02	Auto Restart Fault Output Operation Selection	0, 1	0	×
	L5-04	Fault Reset Interval Time	0.5 to 600.0	10.0 s	×
L5-05	Fault Reset Operation Selection	0, 1	0	×	

Note: Footnotes are listed on page 23.

Function	No.	Name	Range	Default	Online Changing
Torque Detection	L6-01	Torque Detection Selection 1	0 to 8	0	×
	L6-02	Torque Detection Level 1	0 to 300	150%	×
	L6-03	Torque Detection Time 1	0.0 to 10.0	0.1 s	×
	L6-04	Torque Detection Selection 2	0 to 8	0	×
	L6-05	Torque Detection Level 2	0 to 300	150%	×
	L6-06	Torque Detection Time 2	0.0 to 10.0	0.1 s	×
	L6-08	Mechanical Weakening Detection Operation	0 to 8	0	×
	L6-09	Mechanical Weakening Detection Speed Level	-110.0 to 110.0	110.0%	×
	L6-10	Mechanical Weakening Detection Time	0.0 to 10.0	0.1 s	×
	L6-11	Mechanical Weakening Detection Start Time	0 to 65535	0	×
	Torque Limit	L7-01	Forward Torque Limit	0 to 300	200%
L7-02		Reverse Torque Limit	0 to 300	200%	×
L7-03		Forward Regenerative Torque Limit	0 to 300	200%	×
L7-04		Reverse Regenerative Torque Limit	0 to 300	200%	×
L7-06		Torque Limit Integral Time Constant	5 to 10000	200 ms	×
L7-07		Torque Limit Control Method Selection during Accel/Decel	0, 1	0	×
L7-16		Torque Limit Delay at Start	0, 1	1	×
Drive Protection	L8-01	Internal Dynamic Braking Resistor Protection Selection (ERF type)	0, 1	0	×
	L8-02	Overheat Alarm Level	50 to 130	*2	×
	L8-03	Overheat Pre-Alarm Operation Selection	0 to 4	3	×
	L8-05	Input Phase Loss Protection Selection	0, 1	0	×
	L8-07	Output Phase Loss Protection	0 to 2	0	×
	L8-09	Output Ground Fault Detection Selection	0, 1	1	×
	L8-10	Heatsink Cooling Fan Operation Selection	0, 1	0	×
	L8-11	Heatsink Cooling Fan Off Delay Time	0 to 300	60 s	×
	L8-12	Ambient Temperature Setting	-10 to 50	40°C	×
	L8-15	oL2 Characteristics Selection at Low Speeds	0, 1	1	×
	L8-18	Software Current Limit Selection	0, 1	0	×
	L8-19	Frequency Reduction Rate during oH Pre-Alarm	0.1 to 0.9	0.8	×
	L8-27	Overcurrent Detection Gain	0.0 to 300.0	300.0%	×
	L8-29	Current Unbalance Detection (LF2)	0, 1	1	×
	L8-32	Magnetic Contactor, Fan Power Supply Fault Selection	0 to 4	1	×
	L8-35	Installation Method Selection	0 to 3	*1 *2	×
	L8-38	Carrier Frequency Reduction Selection	0 to 2	*2	×
	L8-40	Carrier Frequency Reduction Off Delay Time	0.00 to 2.00	*3	×
	L8-41	High Current Alarm Selection	0, 1	0	×
L8-55	Internal Braking Transistor Protection	0, 1	1	×	
L8-78*8	Power Unit Output Phase Loss Protection	0, 1	1	×	
Hunting Prevention	n1-01	Hunting Prevention Selection	0, 1	1	×
	n1-02	Hunting Prevention Gain Setting	0.00 to 2.50	1.00	×
	n1-03	Hunting Prevention Time Constant	0 to 500	*4	×
	n1-05	Hunting Prevention Gain while in Reverse	0.00 to 2.50	0.00	×
	Speed Feedback Detection Control (ASR) Tuning	n2-01	Speed Feedback Detection Control (AFR) Gain	0.00 to 10.00	1.00
n2-02		Speed Feedback Detection Control (AFR) Time Constant 1	0 to 2000	50 ms	×
n2-03		Speed Feedback Detection Control (AFR) Time Constant 2	0 to 2000	750 ms	×
High Slip Braking and Overexcitation Braking	n3-01	High-Slip Braking Deceleration Frequency Width	1 to 20	5%	×
	n3-02	High-Slip Braking Current Limit	100 to 200	*2	×
	n3-03	High-Slip Braking Dwell Time at Stop	0.0 to 10.0	1.0 s	×
	n3-04	High-Slip Braking Overload Time	30 to 1200	40 s	×
	n3-13	Overexcitation Deceleration Gain	1.00 to 1.40	1.10	×
	n3-14	High Frequency Injection during Overexcitation Deceleration	0, 1	0	×
	n3-21	High-Slip Suppression Current Level	0 to 150	100%	×
n3-23	Overexcitation Operation Selection	0 to 2	0	×	
Feed Forward Control	n5-01	Feed Forward Control Selection	0, 1	0	×
	n5-02	Motor Acceleration Time	0.001 to 10.000	*2 dep. on E5-01	×
	n5-03	Feed Forward Control Gain	0.00 to 100.00	1.00	×



Function	No.	Name	Range	Default	Online Changing
Online Tuning	n6-01	Online Tuning Selection	0 to 2	0	×
	n6-05	Online Tuning Gain	0.10 to 5.00	1.00	×
PM Motor Control Tuning	n8-01	Initial Rotor Position Estimation Current	0 to 100	50%	×
	n8-02	Pole Attraction Current	0 to 150	80%	×
	n8-35	Initial Rotor Position Detection Selection	0 to 2	1	×
	n8-45	Speed Feedback Detection Control Gain	0.00 to 10.00	0.80	×
	n8-47	Pull-In Current Compensation Time Constant	0.0 to 100.0	5.0 s	×
	n8-48	Pull-In Current	20 to 200	30%	×
	n8-49	d-Axis Current for High Efficiency Control	-200.0 to 0.0	dep. on E5-01	×
	n8-51	Acceleration/Deceleration Pull-In Current	0 to 200	50%	×
	n8-54	Voltage Error Compensation Time Constant	0.00 to 10.00	1.00 s	×
	n8-55	Load Inertia	0 to 3	0	×
	n8-57	High Frequency Injection	0, 1	0	×
	n8-62	Output Voltage Limit	0.0 to 230.0*5	200.0 Vac*5	×
	n8-65	Speed Feedback Detection Control Gain during ov Suppression	0.00 to 10.00	1.50	×
	n8-84	Pole Detection Current	0 to 150	100%	×
Digital Operator Display Selection	o1-01	Drive Mode Unit Monitor Selection	104 to 809	106	○
	o1-02	User Monitor Selection After Power Up	1 to 5	1	○
	o1-03	Digital Operator Display Selection	0 to 3	*3	×
	o1-04	V/f Pattern Display Unit	0, 1	*3	×
	o1-10	User-Set Display Units Maximum Value	1 to 60000	*2	×
	o1-11	User-Set Display Units Decimal Display	0 to 3	*2	×
Digital Operator Keypad Functions	o2-01	LO/RE Key Function Selection	0, 1	1	×
	o2-02	STOP Key Function Selection	0, 1	1	×
	o2-03	User Parameter Default Value	0 to 2	0	×
	o2-04	Drive Model Selection	-	dep. on drive capacity	×
	o2-05	Frequency Reference Setting Method Selection	0, 1	0	×
	o2-06	Operation Selection when Digital Operator is Disconnected	0, 1	0	×
	o2-07	Motor Direction at Power Up when Using Operator	0, 1	0	×
	o2-09	Reserved	-	-	×
	Copy Function	o3-01	Copy Function Selection	0 to 3	0
o3-02		Copy Allowed Selection	0, 1	0	×
Maintenance Monitor Settings	o4-01	Cumulative Operation Time Setting	0 to 9999	0 H	×
	o4-02	Cumulative Operation Time Selection	0, 1	0	×
	o4-03	Cooling Fan Operation Time Setting	0 to 9999	0 H	×
	o4-05	Capacitor Maintenance Setting	0 to 150	0%	×
	o4-07	DC Bus Pre-charge Relay Maintenance Setting	0 to 150	0%	×
	o4-09	IGBT Maintenance Setting	0 to 150	0%	×
	o4-11	U2, U3 Initialize Selection	0, 1	0	×
	o4-12	kWh Monitor Initialization	0, 1	0	×
	o4-13	Number of Run Commands Counter Initialization	0, 1	0	×
DWEZ Parameters	q1-01 to q6-07	DWEZ Parameters	-	-	×

- \*1: Parameter is not reset to the default value when the drive is initialized (A1-03).
- \*2: Value depends on other related parameter settings. Refer to A1000 Technical Manual for details.
- \*3: Default setting depends on the control mode (A1-02). Refer to A1000 Technical Manual for details.
- \*4: Default setting depends on drive capacity (o2-04). Refer to A1000 Technical Manual for details.
- \*5: Value shown here is for 200 V class drives. Double the value when using a 400 V class drive.
- \*6: Value in parenthesis is the default setting for a 3-wire sequence.
- \*7: Sets the value for a SST4 series 1750 r/min motor according to the capacity entered to T2-02.
- \*8: Parameter L8-78 is available only for drives 450 kW and above.

Function	No.	Name	Range	Default	Online Changing
DWEZ Connection Parameters	r1-01 to r1-40	DWEZ Connection Parameter 1 to 20 (upper/lower)	0 to FFFFH	0	×
	T1-00	Motor 1 / Motor 2 Selection	1, 2	1	×
Induction Motor Auto-Tuning	T1-01	Auto-Tuning Mode Selection	0 to 4,8,9*3	0	×
	T1-02	Motor Rated Power	0.00 to 650.00	*4	×
	T1-03	Motor Rated Voltage	0.0 to 255.0*5	200.0 Vac*5	×
	T1-04	Motor Rated Current	10% to 200% of the drive rated current	*4	×
	T1-05	Motor Base Frequency	0.0 to 400.0	60.0 Hz	×
	T1-06	Number of Motor Poles	2 to 48	4	×
	T1-07	Motor Base Speed	0 to 24000	1750 r/min	×
	T1-08	PG Number of Pulses Per Revolution	0 to 60000	600 ppr	×
	T1-09	Motor No-Load Current (Stationary Auto-Tuning)	0 to T1-04	-	-
	T1-10	Motor Rated Slip (Stationary Auto-Tuning)	0.00 to 20.00	-	-
	T1-11	Motor Iron Loss	0 to 65535	14 W*2	×
	T2-01	PM Motor Auto-Tuning Mode Selection	0 to 3,8,9*3	0	×
	T2-02	PM Motor Code Selection	0000 to FFFF	*2	×
	T2-03	PM Motor Type	0,1	1	×
	T2-04	PM Motor Rated Power	0.00 to 650.00	*4	×
	T2-05	PM Motor Rated Voltage	0.0 to 255.0*5	200.0 Vac*5	×
	T2-06	PM Motor Rated Current	10% to 200% of the drive rated current	*4	×
PM Motor Auto-Tuning	T2-07	PM Motor Base Frequency	0.0 to 400.0	87.5 Hz	×
	T2-08	Number of PM Motor Poles	2 to 48	6	×
	T2-09	PM Motor Base Speed	0 to 24000	1750 r/min	×
	T2-10	PM Motor Stator Resistance	0.000 to 65.000	*7	×
	T2-11	PM Motor d-Axis Inductance	0.00 to 600.00	*7	×
	T2-12	PM Motor q-Axis Inductance	0.00 to 600.00	*7	×
	T2-13	Induced Voltage Constant Unit Selection	0, 1	1	×
	T2-14	PM Motor Induced Voltage Constant	0.1 to 2000.0	*7	×
	T2-15	Pull-In Current Level for PM Motor Tuning	0 to 120	30%	-
	T2-16	PG Number of Pulses Per Revolution for PM Motor Tuning	0 to 15000	1024 ppr	-
	T2-17	Encoder Z Pulse Offset	-180.0 to 180.0	0.0 deg	×
ASR and Inertia Tuning	T3-01	Test Signal Frequency	0.1 to 20.0	3.0 Hz	×
	T3-02	Test Signal Amplitude	0.1 to 10.0	0.5 rad	×
	T3-03	Motor Inertia	0.0001 to 600.00	*2 dep. on E5-01	×
	T3-04	System Response Frequency	0.1 to 50.0	10.0 Hz	×

# Basic Instructions

## Outstanding operability and quick setup

### Operator Names and Functions

**Up arrow key**  
Scrolls up through the display screen, and increases a selected value.

**ESC key**  
Lets the user back up to the previous display screen.

**Right arrow key**  
Scrolls the cursor to the right.

**RESET key**  
Resets a fault.

**Glossary**  
Used as a quick guide for the abbreviations used on the display screen. Details listed on the next page.

**Down arrow key**  
Scrolls down through the display screen, and decreases a selected value.

**RUN key**  
Issues a Run command.

**LED panel**  
More information listed below.

**Data display (5-digit)**  
Displays frequency, parameter number, and other data.

**LO/RE light**  
Lights to indicate that the operator is set for LOCAL.

**LO/RE key**  
Determines where the Run command and frequency reference come from: the keypad (LOCAL) or the control terminals (REMOTE).

**ENTER key**  
Press to enter values, edit parameters, and set the control mode. Press this key to proceed to the next screen when scrolling through various menu displays.

**STOP key**  
Issues a Stop command.

**Com port**  
For connecting to a PC (DriveWizard or DriveWorksEZ), a USB copy unit or a LCD operator.

**Lights during communications**

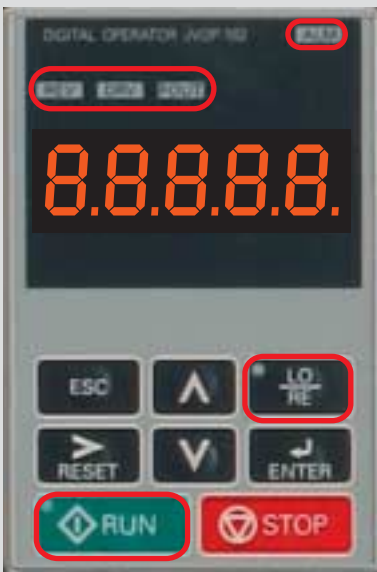

### LED Display Guide

LED	ON	Flashing	OFF
ALM	A fault has occurred.	<ul style="list-style-type: none"> <li>Alarm situation detected.</li> <li>Operator error (OPE)</li> </ul>	Normal operation
REV	Motor is rotating in reverse.	—	Motor is rotating forward.
DRV	In the "Drive Mode"	—	Programming Mode
FOUT	Output frequency	—	—
LO/RE	Run command assigned to the operator (LOCAL)	—	Control assigned to remote location
RUN	During run	<ul style="list-style-type: none"> <li>During deceleration</li> <li>Run command is present but the frequency reference is zero.</li> </ul>	Drive is stopped.

### How the RUN light works:

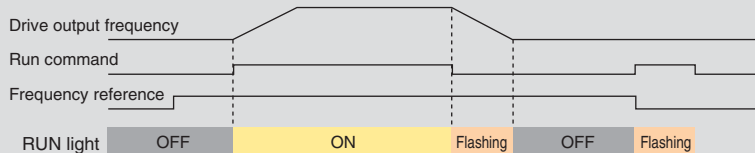



## Operation Example

### Using the LED Operator to Run the Drive

Steps	Key	Result/Display
1 Turn the power on.		F 0.00
2 Set the drive for LOCAL. The frequency reference is displayed.	LO RE	LO Should light F 0.00
3 Displays the direction (forward/reverse).	↑	For
4 Displays the output frequency.	↑	0.00
5 Displays the output current.	↑	0.00A
6 Displays the output voltage.	↑	0.00V
7 Displays the beginning of the Monitor Menu.	↑	flashing r7on
8 Displays the top of the Verify Menu.	↑	flashing urF4
9 Displays the top of the Setup Mode.	↑	flashing SfUP
10 Displays the top of the parameter settings menu.	↑	Pr
11 Displays the top of the Auto-Tuning Mode.	↑	ArUn
Returns back to the frequency reference display.	↑	

Value will flash when it is possible to change the setting.

**Drive Mode:** Run and Stop commands, displays operation status such as the frequency reference, output frequency, output current, output voltage, etc.

How to Monitor the Frequency Reference

Steps	Key	Result/Display
Use the arrow keys to select the digits to set.	ENTER	F00.00
	RESET	F00.00
	↑ ↓	F06.00
	ENTER	F06.00
Press enter to save the new value.	ENTER	DRV DRV lights up.

**Monitor Mode:** Displays operation status and information on faults.

Steps	Key	Result/Display
Selecting a Monitor for Display. Displays U1-01, the frequency reference monitor.	ENTER	U1-01
	ENTER	6.00
	ESC	U1-01
	↑	U1-02
Re-select the monitor display menu.	↑	U1-26
Back up to the top of the Monitor Menu.	ESC Press once.	r7on

**Verify Menu:** Lists all parameters that have been changed from their original default settings, either by the user or from Auto-Tuning.

Steps	Key	Result/Display
Lists parameters that have been changed in order. Pressing Enter displays the parameter value.	ENTER	C1-01
	ENTER	0003.0
	ESC	C1-01
	↑	C1-02
Parameters that have been changed from their default values are listed in order.	↑	C6-02
Returns to the top of the Verify Menu	ESC Press once.	urF4

Press ESC to go back to the previous display screen

## Setup Mode

The list of Applications Presets can be accessed in the Setup Mode. Each Application Preset automatically programs drive parameters to their optimal settings specific to the application selected. All parameters affected by the Application Preset are then listed as Preferred Parameters for quick access.

Selecting a Conveyor (A1-06=1)

Steps	Key	Result/Display
Application Selection	ENTER	APPL
	ENTER	00
	RESET	00
Select, "Conveyor".	↑	02
All parameters relating to the preset values for a Conveyor application are then listed as Preferred Parameters.	ENTER	APPL

↑ Scroll to the Preferred Parameter using the up arrow key and see which parameters have been selected.

### Conveyor Application Presets

No.	Parameter Name	Optimum Setting
A1-02	Control Method Selection	0: V/f Control
C1-01	Acceleration Time 1	3.0 (s)
C1-02	Deceleration Time 1	3.0 (s)
C6-01	Duty Mode Selection	0: Heavy Duty (HD)
L3-04	Stall Prevention Selection during Deceleration	1: Enabled

### Preferred Parameters

No.	Parameter Name	No.	Parameter Name
A1-02	Control Method Selection	C1-02	Deceleration Time 1
b1-01	Frequency Reference Selection 1	E2-01	Motor Rated Current
b1-02	Run Command Selection 1	L3-04	Stall Prevention Selection during Deceleration
C1-01	Acceleration Time 1	-	-



# Standard Specifications

Parameter C6-01 sets the drive for Normal Duty or Heavy Duty performance (default).

## 200 V Class

ND : Normal Duty, HD : Heavy Duty

Model CIMR-AA2A:		0004	0006	0008*7	0010	0012	0018*7	0021	0030	0040	0056	0069	0081	0110	0138	0169	0211	0250	0312	0360	0415	
Max. Applicable	ND	0.75	1.1	1.5	2.2	3	3.7	5.5	7.5	11	15	18.5	22	30	37	45	55	75	90	110	110	
Motor Capacity*1	kW	0.4	0.75	1.1	1.5	2.2	3	3.7	5.5	7.5	11	15	18.5	22	30	37	45	55	75	90	110	
Input	Rated Input	ND	3.9	7.3	8.8	10.8	13.9	18.5	24	37	52	68	80	92	111	136	164	200	271	324	394	471
	Current*2	A	HD	2.9	5.8	7	7.5	11	15.6	18.9	28	37	52	68	80	82	111	136	164	200	271	324
Output	Rated Output	ND*4	1.3	2.3	3	3.7	4.6	6.7	8	11.4	15.2	21	26	31	42	53	64	80	95	119	137	158
	Capacity*3	kVA	HD	1.2*5	1.9*5	2.6*5	3*5	4.2*5	5.3*5	6.7*5	9.5*5	12.6*5	17.9*5	23*5	29*5	32*5	44*5	55*6	69*6	82*6	108*6	132*6
Output	Rated Output	ND*4	3.5	6	8	9.6	12	17.5	21	30	40	56	69	81	110	138	169	211	250	312	360	415
	Current	A	HD	3.2*5	5*5	6.9*5	8*5	11*5	14*5	17.5*5	25*5	33*5	47*5	60*5	75*5	85*5	115*5	145*6	180*6	215*6	283*6	346*6
Power	Overload Tolerance	ND Rating*8: 120% of rated output current for 60 s, HD Rating*8: 150% of rated output current for 60 s (Derating may be required for repetitive loads)																				
	Carrier Frequency	1 to 15 kHz*8															1 to 10 kHz*8					
	Max. Output Voltage	Three-phase 200 to 240 V (relative to input voltage)																				
	Max. Output Frequency	400 Hz*8																				
	Rated Voltage/Rated Frequency	Three-phase AC power supply: 200 to 240 Vac 50/60 Hz, DC power supply: 270 to 340 Vdc*9																				
Power	Allowable Voltage Fluctuation	-15% to +10%																				
	Allowable Frequency Fluctuation	±5%																				
	Power Supply	ND	2.2	3.1	4.1	5.8	7.8	9.5	14	18	27	36	44	52	51	62	75	91	124	148	180	215
	kVA	HD	1.3	2.2	3.1	4.1	5.8	7.8	9.5	14	18	27	36	44	37	51	62	75	91	124	148	180
Harmonic Suppression	DC Reactor	Option												Built-in								
Braking Function	Braking Resistor	Built-in												Option								

- \*1: The motor capacity (kW) refers to a Yaskawa 4-pole, 60 Hz, 200 V motor. The rated output current of the drive output amps should be equal to or greater than the motor rated current.
- \*2: Value displayed is for when operating at the rated output current. This value may fluctuate based on the power supply side impedance, as well as the input current, power supply transformer, input side reactor, and wiring conditions.
- \*3: Rated output capacity is calculated with a rated output voltage of 220 V.
- \*4: This value assumes a carrier frequency of 2 kHz. Increasing the carrier frequency requires a reduction in current.
- \*5: This value assumes a carrier frequency of 8 kHz. Increasing the carrier frequency requires a reduction in current.
- \*6: This value assumes a carrier frequency of 5 kHz. Increasing the carrier frequency requires a reduction in current.
- \*7: These models are available in Japan only.
- \*8: Carrier frequency can be set by the user.
- \*9: Use of a DC power supply is not UL and CE approved.

## 400 V Class

ND : Normal Duty, HD : Heavy Duty

Model CIMR-AA4A:		0002	0004	0005	0007	0009	0011	0018	0023	0031	0038	0044	0058	0072	0088	0103	0139	0165	0208	0250	0296	0362	0414	0515	0675	0930	1200		
Max. Applicable	ND	0.75	1.5	2.2	3	3.7	5.5	7.5	11	15	18.5	22	30	37	45	55	75	90	110	132	160	185	220	250	355	500	630		
Motor Capacity*1	kW	0.4	0.75	1.5	2.2	3	3.7	5.5	7.5	11	15	18.5	22	30	37	45	55	75	90	110	132	160	185	220	315	450	560		
Input	Rated Input	ND	2.1	4.3	5.9	8.1	9.4	14	20	24	38	44	52	58	71	86	105	142	170	207	248	300	346	410	465	657	922	1158	
	Current*2	A	HD	1.8	3.2	4.4	6	8.2	10.4	15	20	29	39	44	43	58	71	86	105	142	170	207	248	300	346	410	584	830	1031
Output	Rated Output	ND*4	1.6	3.1	4.1	5.3	6.7	8.5	13.3	17.5	24	29	34	44	55	67	78	106	126	159	191	226	276	316	392	514	709	915	
	Capacity*3	kVA	HD	1.4*5	2.6*5	3.7*5	4.2*5	5.5*5	7*5	11.3*5	13.7*5	18.3*5	24*5	30*5	34*5	46*5	57*5	69*5	85*5	114*6	137*6	165*6	198*6	232*6	282*6	343*4	461*4	617*4	831*4
Output	Rated Output	ND*4	2.1	4.1	5.4	6.9	8.8	11.1	17.5	23	31	38	44	58	72	88	103	139	165	208	250	296	362	414	515	675	930	1200	
	Current	A	HD	1.8*5	3.4*5	4.8*5	5.5*5	7.2*5	9.2*5	14.8*5	18*5	24*5	31*5	39*5	45*5	60*5	75*5	91*5	112*5	150*6	180*6	216*6	260*6	304*6	370*6	450*4	605*4	810*4	1090*4
Power	Overload Tolerance	ND Rating*7: 120% of rated output current for 60 s, HD Rating*7: 150% of rated output current for 60 s (Derating may be required for repetitive loads)																											
	Carrier Frequency	1 to 15 kHz*7															1 to 10 kHz*7						1 to 5 kHz*7						
	Max. Output Voltage	Three-phase 380 to 480 V (relative to input voltage)																											Input voltage x 0.95
	Max. Output Frequency	400 Hz*7																											
	Rated Voltage/Rated Frequency	Three-phase AC power supply: 380 to 480 Vac 50/60 Hz, DC power supply: 510 to 680 Vdc*8																											
Power	Allowable Voltage Fluctuation	-15% to +10%																											
	Allowable Frequency Fluctuation	±5%																											
	Power Supply	ND	2.3	4.3	6.1	8.1	10	14.4	19.4	28.4	37.5	46.6	54.9	53	64.9	78.6	96	130	156	189	227	274	316	375	416	601	843	1059	
	kVA	HD	1.4	2.3	4.3	6.1	8.1	10	14.6	19.2	28.4	37.5	46.6	39.3	53	64.9	78.6	96	130	156	189	227	274	316	375	508	759	943	
Harmonic Suppression	DC Reactor	Option												Built-in															
Braking Function	Braking Resistor	Built-in												Option															

- \*1: The motor capacity (kW) refers to a Yaskawa 4-pole, 60 Hz, 400 V motor. The rated output current of the drive output amps should be equal to or greater than the motor rated current.
- \*2: Value displayed is for when operating at the rated output current. This value may fluctuate based on the power supply side impedance, as well as the input current, power supply transformer, input side reactor, and wiring conditions.
- \*3: Rated output capacity is calculated with a rated output voltage of 440 V.
- \*4: This value assumes a carrier frequency of 2 kHz. Increasing the carrier frequency requires a reduction in current.
- \*5: This value assumes a carrier frequency of 8 kHz. Increasing the carrier frequency requires a reduction in current.
- \*6: This value assumes a carrier frequency of 5 kHz. Increasing the carrier frequency requires a reduction in current.
- \*7: Carrier frequency can be set by the user.
- \*8: Use of a DC power supply is not UL and CE approved.



## Common Specifications

Item	Specifications	
Control Characteristics	Control Method	V/f Control, V/f Control with PG, Open Loop Vector Control, Closed Loop Vector Control, Open Loop Vector Control for PM, Advanced Open Loop Vector Control for PM, Closed Loop Vector Control for PM
	Frequency Control Range	0.01 to 400 Hz
	Frequency Accuracy (Temperature Fluctuation)	Digital reference: within $\pm 0.01\%$ of the max. output frequency ( $-10$ to $+40^\circ\text{C}$ ) Analog reference: within $\pm 0.1\%$ of the max. output frequency ( $25 \pm 10^\circ\text{C}$ )
	Frequency Setting Resolution	Digital reference: 0.01 Hz Analog reference: 0.03 Hz / 60 Hz (11 bit)
	Output Frequency Resolution	0.001 Hz
	Frequency Setting Resolution	$-10$ to $+10$ V, $0$ to $+10$ V, $4$ to $20$ mA, pulse train
	Starting Torque	150%/3 Hz (V/f Control and V/f Control with PG), 200%/0.3 Hz* <sup>1</sup> (Open Loop Vector Control), 200%/0 r/min* <sup>1</sup> (Closed Loop Vector Control, Closed Loop Vector Control for PM, and Advanced Open Loop Vector Control for PM), 100%/5% speed (Open Loop Vector Control for PM)
	Speed Control Range	1:1500 (Closed Loop Vector Control and Closed Loop Vector Control for PM) 1:200 (Open Loop Vector Control) 1:40 (V/f Control and V/f Control with PG) 1:20 (Open Loop Vector Control for PM) 1:100 (Advanced Open Loop Vector Control for PM)
	Speed Control Accuracy	$\pm 0.2\%$ in Open Loop Vector Control ( $25 \pm 10^\circ\text{C}$ ) * <sup>2</sup> , $\pm 0.02\%$ in Closed Loop Vector Control ( $25 \pm 10^\circ\text{C}$ )
	Speed Response	10 Hz in Open Loop Vector Control ( $25 \pm 10^\circ\text{C}$ ), 50 Hz in Closed Loop Vector Control ( $25 \pm 10^\circ\text{C}$ ) (excludes temperature fluctuation when performing Rotational Auto-Tuning)
	Torque Limit	All vector control modes allow separate settings in four quadrants
	Accel/Decel Time	0.00 to 6000.0 s (4 selectable combinations of independent acceleration and deceleration settings)
	Braking Torque* <sup>3</sup>	Approximately 20% (up to approx. 125% with a braking option) 200/400 V models up to 30 kW have the following braking transistor built-in (CIMR-AA2A0138/AA4A0072) ① Short-time decel torque* <sup>4</sup> : over 100% for 0.4/ 0.75 kW motors, over 50% for 1.5 kW motors, and over 20% for 2.2 kW and above motors (Overexcitation Deceleration, High Slip Braking: approx. 40%) ② Continuous regen. torque: approx. 20% (approx. 125% with dynamic braking resistor option* <sup>5</sup> : 10% ED, 10 s)
	V/f Characteristics	User-selected programs and V/f preset patterns possible
Main Control Functions	Torque Control, Droop Control, Speed/Torque Control switch, Feed Forward Control, Zero Servo Control, Momentary Power Loss Ride-Thru, Speed Search, Overtorque detection, torque limit, 17 Step Speed (max.), accel/decel time switch, S-curve accel/decel, 3-wire sequence, Auto-Tuning (rotational, stationary), Online Tuning, Dwell, cooling fan on/off switch, slip compensation, torque compensation, Frequency Jump, Upper/lower limits for frequency reference, DC Injection Braking at start and stop, Overexcitation Deceleration, High Slip Braking, PID control (with Sleep function), Energy Saving Control, MEMOBUS comm. (RS-485/422, max. 115.2 kbps), Fault Restart, Application Presets, DriveWorksEZ (customized functions), Removable Terminal Block with Parameter Backup...	
Protection Function	Motor Protection	Motor overheat protection based on output current
	Momentary Overcurrent Protection	Stops over 200% rated output current (Heavy Duty)
	Overload Protection	Drive stops after 60 s at 150% of rated output current (when set for Heavy Duty performance)* <sup>6</sup>
	Overvoltage Protection	200 V class: Stops when DC bus exceeds approx. 410 V, 400 V class: Stops when DC bus exceeds approx. 820 V
	Undervoltage Protection	200 V class: Stops when DC bus exceeds approx. 190 V, 400 V class: Stops when DC bus exceeds approx. 380 V
	Momentary Power Loss Ride-Thru	Stops immediately after 15 ms or longer power loss (default). Continuous operation during power up to 2 s (standard).* <sup>7</sup>
	Heatsink Overheat Protection	Thermistor
	Braking Resistance Overheat Protection	Overheat sensor for braking resistor (optional ERF-type, 3% ED)
	Stall Prevention	Stall prevention during acceleration/deceleration and constant speed operation
	Ground Fault Protection	Protection by electronic circuit * <sup>8</sup>
	Charge LED	Charge LED remains lit until DC bus has fallen below approx. 50 V
Environment	Area of Use	Indoors
	Ambient Temperature	$-10$ to $+50^\circ\text{C}$ (open-chassis), $-10$ to $+40^\circ\text{C}$ (NEMA Type 1)
	Humidity	95% RH or less (no condensation)
	Storage Temperature	$-20$ to $+60^\circ\text{C}$ (short-term temperature during transportation)
	Altitude	Up to 1000 meters (derating is required for operation at altitudes 1000 to 3000 m)
	Shock	10 Hz to 20 Hz, 9.8 m/s <sup>2</sup> max. (5.9 m/s <sup>2</sup> for models larger than 400 V 450 kW) 20 Hz to 55 Hz, 5.9 m/s <sup>2</sup> (200 V: 45 kW or more, 400 V: 55 kW or more) or 2.0 m/s <sup>2</sup> max. (200 V: 55 kW or less, 400 V: 75 kW or less)
Standards Compliance	UL 508C, EN61800-3, EN61800-5-1, EN954-1 Cat. 3, ISO 13849-1 (Cat. 3, PLd), IEC/EN61508 SIL2	
Protection Design	IP00 open-chassis, IP20 NEMA Type 1 enclosure * <sup>9</sup>	

\*1: Requires a drive with recommended capacity.

\*2: Speed control accuracy may vary slightly depending on installation conditions or motor used. Contact Yaskawa for details.

\*3: Varies by motor characteristics.

\*4: Momentary average deceleration torque refers to the deceleration torque from 60 Hz down to 0 Hz. This may vary depending on the motor.

\*5: If L3-04 is enabled when using a braking resistor or braking resistor unit, the motor may not stop within the specified deceleration time.

\*6: Overload protection may be triggered when operating with 150% of the rated output current if the output frequency is less than 6 Hz.

\*7: Varies in accordance with drive capacity and load. Drives with a capacity of smaller than 11 kW in the 200 V (model: CIMR-AA2A0056) or 400 V (model: CIMR-AA4A0031) require a separate Momentary Power Loss Recovery Unit to continue operating during a momentary power loss of 2 s or longer.

\*8: Protection may not be provided under the following conditions as the motor windings are grounded internally during run:

- Low resistance to ground from the motor cable or terminal block.
- Drive already has a short-circuit when the power is turned on.

\*9: Removing the cover of changes the drive's NEMA Type 1 rating to IP20 (models 2A0004 to 2A0081 and 4A0002 to 4A0044).



# Standard Connection Diagram

## Standard Connection Diagram

Example: 200 V Class 3.7 kW

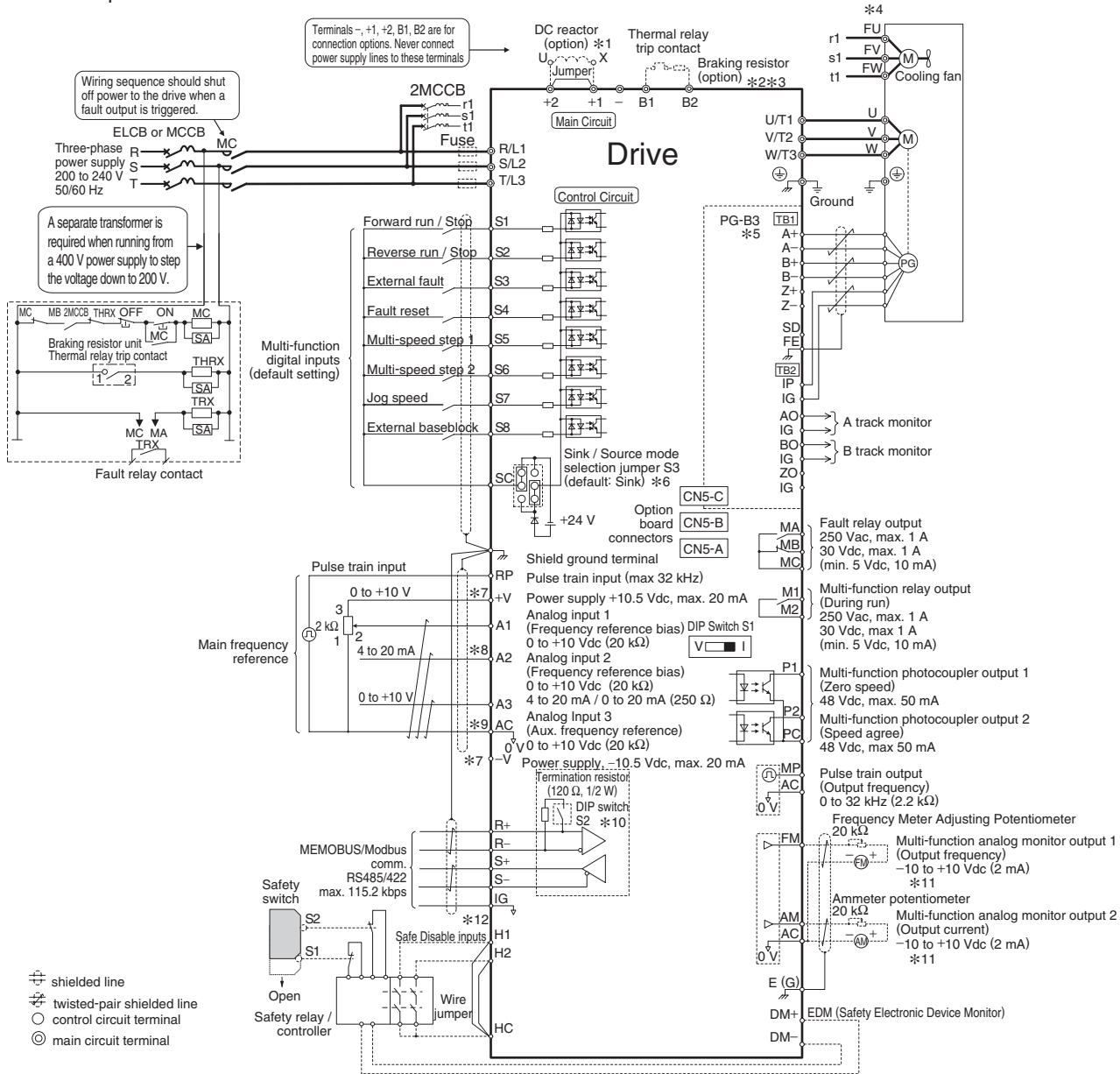

- \*1: Remove the jumper when installing a DC reactor. Certain models come with a built-in DC reactor: CIMR-2A0110 and above, CIMR-4A0058 and above.
- \*2: Make sure Stall Prevention is disabled (L3-04 = 0) whenever using a braking resistor. If left enabled, the drive may not stop within the specified deceleration time.
- \*3: Enable the drive's braking resistor overload protection by setting L8-01 = 1 when using ERF type braking resistors. Wire the thermal overload relay between the drive and the braking resistor and connect this signal to a drive digital input. Use this input to trigger a fault in the drive in case of a braking resistor overload.
- \*4: Self-cooling motors do not require wiring that would be necessary with motors using a cooling fan.
- \*5: For control modes that do not use a motor speed feedback signal, PG option card wiring is not necessary.
- \*6: This figure shows an example of a sequence input to S1 through S8 using a non-powered relay or an NPN transistor (0 V common/sink mode: default). When sequence connections by PNP transistor (+24 V common/source mode) or preparing an external +24 V power supply, refer to A1000 Technical Manual for details.
- \*7: The maximum output current capacity for the +V and -V terminals on the control circuit is 20 mA. Never short terminals +V, -V, and AC, as this can cause erroneous operation or damage the drive.
- \*8: Set DIP switch S1 to select between a voltage or current input signal to terminal A2. The default setting is for voltage input.
- \*9: Never connect to the AC terminal ground or chassis. This can result in erroneous operation or cause a fault.
- \*10: Enable the termination resistor in the last drive in a MEMOBUS/Modbus network by setting DIP switch S2 to the ON position.
- \*11: Monitor outputs work with devices such as analog frequency meters, ammeters, voltmeters, and wattmeters. Do not use these outputs in a feedback loop.
- \*12: Disconnect the wire jumper between HC - H1 and HC - H2 when utilizing the Safe Disable input.
  - The sink/source setting for the Safe Disable input is the same as with the sequence input. Jumper S3 has the drive set for an external power supply. When not using the Safe Disable input feature, remove the jumper shorting the input and connect an external power supply.
  - Time from input open to drive output stop is less than 1 ms. The wiring distance for the Safe Disable inputs should not exceed 30 m.

Note: When an Application Preset is selected, the drive I/O terminal functions change.

### Control Circuit and Serial Communication Circuit Terminal Layout

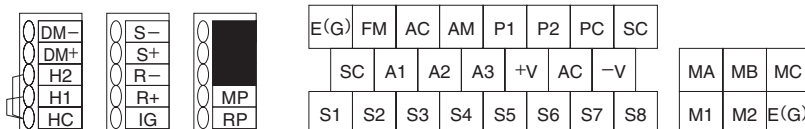

# Terminal Functions

## Main Circuit Terminals

Max. Applicable Motor Capacity indicates Heavy Duty

Voltage		200 V			400 V		
Model CIMR-AA: [ ]	2A0004 to 2A0081	2A0110, 2A0138	2A0169 to 2A0415	4A0002 to 4A0044	4A0058, 4A0072	4A0088 to 4A1200	
Max. Applicable Motor Capacity kW	0.4 to 18.5	22, 30	37 to 110	0.4 to 18.5	22, 30	37 to 560	
R/L1, S/L2, T/L3	Main circuit input power supply			Main circuit input power supply			
U/T1, V/T2, W/T3	Drive output			Drive output			
B1, B2	Braking resistor unit		–	Braking resistor unit		–	
–	· DC reactor (+1, +2)	DC power supply (+1, –)*	DC power supply (+1, –)* Braking unit (+3, –)	· DC reactor (+1, +2)	DC power supply (+1, –)*	DC power supply (+1, –)* Braking unit (+3, –)	
+1	· DC power supply (+1, –)*			· DC power supply (+1, –)*			
+2	–			–			
+3	–			–			
⊕	Ground terminal (100 Ω or less)			Ground terminal (10 Ω or less)			

\* DC power supply input terminals (+1, –) are not UL and CE certified.

## Control Circuit Input Terminals (200 V/400 V Class)

Terminal Type	Terminal	Signal Function	Description	Signal Level
Multi-Function Digital Input	S1	Multi-function input selection 1	Closed: Forward run (default) Open: Stop (default)	Photocoupler 24 Vdc, 8 mA
	S2	Multi-function input selection 2	Closed: Reverse run (default) Open: Stop (default)	
	S3	Multi-function input selection 3	External fault, N.O. (default)	
	S4	Multi-function input selection 4	Fault reset (default)	
	S5	Multi-function input selection 5	Multi-step speed reference 1 (default)	
	S6	Multi-function input selection 6	Multi-step speed reference 2 (default)	
	S7	Multi-function input selection 7	Jog frequency (default)	
	S8	Multi-function input selection 8	Closed: External baseblock	
	SC	Multi-function input selection common	Multi-function input selection common	
Main Frequency Reference Input	RP	Multi-function pulse train input	Frequency reference (default) (H6-01 = 0)	0 to 32 kHz (3 kΩ)
	+V	Setting power supply	+10.5 V power supply for analog reference (20 mA max.)	
	–V	Setting power supply	–10.5 V power supply for analog reference (20 mA max.)	
	A1	Multi-function analog input 1	–10 to +10 Vdc for –100 to 100%, 0 to +10 Vdc for 0 to 100% (impedance 20 kΩ), Main frequency reference (default)	
	A2	Multi-function analog input 2	DIP switch S1 sets the terminal for a voltage or current input signal –10 to +10 Vdc for –100 to +100%, 0 to +10 Vdc for 0 to 100% (impedance 20 kΩ) 4 to 20 mA for 0 to 100%, 0 to 20 mA for 0 to 100% (impedance 250 Ω) Added to the reference value of the analog frequency for the main frequency reference (default)	
	A3	Multi-function analog input 3	–10 to +10 Vdc for –100 to +100%, 0 to +10 Vdc for 0 to 100% (impedance 20 kΩ) Auxiliary frequency reference (default)	
	AC	Frequency reference common	0 V	
	E(G)	Connection to wire shielding and option card ground wire	–	
Multi-Function Photocoupler Output	P1	Multi-function photocoupler output (1)	Zero speed (default)	48 Vdc, 2 to 50 mA Photocoupler output*1
	P2	Multi-function photocoupler output (2)	Speed agree (default)	
	PC	Photocoupler output common	–	
Fault Relay Output	MA	N.O. output	Closed: Fault	Relay output 250 Vac, 10 mA to 1 A, 30 V, 10 mA to 1 A Minimum load: 5 Vdc, 10 mA
	MB	N.O. output	Open: Fault	
	MC	Digital output common	–	
Multi-Function Digital Output*2	M1	Multi-function digital output	During run (default)	Minimum load: 5 Vdc, 10 mA
	M2		Closed: During run	
Monitor Output	MP	Pulse train input	Output frequency (default) (H6-06 = 102)	0 to 32 kHz (2.2 kΩ)
	FM	Multi-function analog monitor (1)	Output frequency (default)	0 to +10 Vdc for 0 to 100%
	AM	Multi-function analog monitor (2)	Output current (default)	–10 to 10 Vdc for –100 to 100%
	AC	Analog common	0 V	
Safety Input	H1	Safety input 1	24 Vdc 8 mA. One or both open: Output disabled. Both closed: Normal operation.	
	H2	Safety input 2	Internal impedance 3.3 kΩ, switching time at least 1 ms.	
	HC	Safety input common	Safety input common	
Safety Monitor Output	DM+	Safety monitor output	Outputs status of Safe Disable function. Closed	48 Vdc, 50 mA or less
	DM–	Safety monitor output common	when both Safe Disable channels are closed.	

\*1: Connect a flywheel diode as shown below when driving a reactive load such as a relay coil. Diode must be rated higher than the circuit voltage.

\*2: Refrain from assigning functions to terminals M1 and M2 that involve frequent switching, as doing so may shorten relay performance life. Switching life is estimated at 200,000 times (assumes 1 A, resistive load).

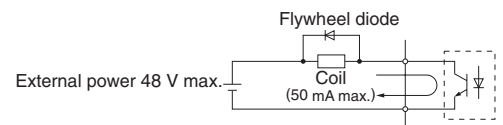

## Serial Communication Terminals (200 V/400 V Class)

Classification	Terminal	Signal Function	Description	Signal Level
MEMOBUS/Modbus Communications	R+	Communications input (+)	MEMOBUS/Modbus communications: Use a RS-485 or RS-422 cable to connect the drive.	RS-422/485 MEMOBUS/Modbus communications protocol 115.2 kbps (max.)
	R–	Communications input (–)		
	S+	Communications output (+)		
	S–	Communications output (–)		
	IG	Shield ground		

## Enclosures

Enclosures of standard products vary depending on the model. Refer to the table below.

### 200 V Class

ND : Normal Duty, HD : Heavy Duty

Model CIMR-AA2A	0004	0006	0008	0010	0012	0018	0021	0030	0040	0056	0069	0081	0110	0138	0169	0211	0250	0312	0360	0415
Max. Applicable	ND 0.75	1.1	1.5	2.2	3	3.7	5.5	7.5	11	15	18.5	22	30	37	45	55	75	90	110	110
Motor Capacity (kW)	HD 0.4	0.75	1.1	1.5	2.2	3	3.7	5.5	7.5	11	15	18.5	22	30	37	45	55	75	90	110
Enclosure Panel [NEMA Type 1]	Standard												Made to order						*	
Open-Chassis	Remove top cover of wall-mount enclosure for IP20 rating												IP00 standard						Order-made	

\* NEMA 1 Type 1 is not available for this capacity.

### 400 V Class

ND : Normal Duty, HD : Heavy Duty

Model CIMR-AA4A	0002	0004	0005	0007	0009	0011	0018	0023	0031	0038	0044	0058	0072	0088	0103	0139	0165	0208	0250	0296	0362	0414	0515	0675	0930	1200
Max. Applicable	ND 0.75	1.5	2.2	3	3.7	5.5	7.5	11	15	18.5	22	30	37	45	55	75	90	110	132	160	185	220	250	355	500	630
Motor Capacity (kW)	HD 0.4	0.75	1.5	2.2	3	3.7	5.5	7.5	11	15	18.5	22	30	37	45	55	75	90	110	132	160	185	220	315	450	560
Enclosure Panel [NEMA Type 1]	Standard												Made to order										*			
Open-Chassis	Remove top cover of wall-mount enclosure for IP20 rating												IP00 standard										Order-made			

\* NEMA 1 Type 1 is not available for this capacity.

### Enclosure Panel [NEMA Type 1]

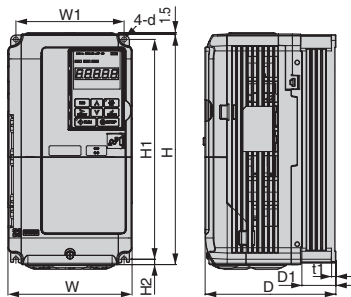

Figure 1

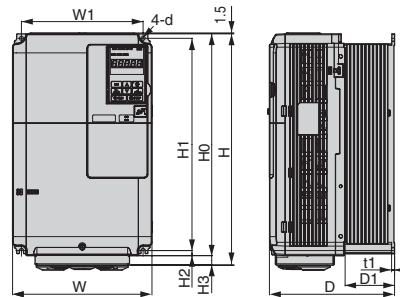

Figure 2

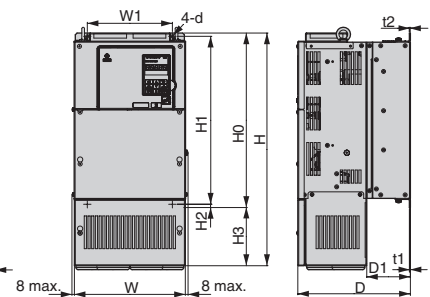

Figure 3

### 200 V Class

Model CIMR-AA2A	Max. Applicable Motor Capacity (kW)		Figure	Dimensions (mm)												Weight (kg)	Cooling															
	Normal Duty	Heavy Duty		W	H	D	W1	H0	H1	H2	H3	D1	t1	t2	d																	
0004	0.75	0.4	1	140	260	147	122	-	248	6	-	38	5	-	M5	3.1	Self cooling															
0006	1.1	0.75																3.2														
0008	1.5	1.1																	164													
0010	2.2	1.5																167														
0012	3.0	2.2																	122	-	248	6	-	55	5	-	-	-	-	-	3.5	Fan cooled
0018	3.7	3.0																180														
0021	5.5	3.7																	220	350	197	192	-	335	8	-	78	5	-	-	-	
0030	7.5	5.5																220														
0040	11	7.5																	254	534	258	195	400	385	7.5	134	100	2.3	2.3	-	-	
0056	15	11																279														
0069	18.5	15	329	730	283	260	550	535	7.5	180	110	2.3	2.3	-	-	41																
0081	22	18.5															456	960	330	325	705	680	12.5	255	130	3.2	3.2	M10	-	83		
0110	30	22	504	1168	350	370	800	773	13	368	130	4.5	4.5	M12	-	88																
0138	37	30															504	1168	350	370	800	773	13	368	130	4.5	4.5	M12	-	108		
0169	45	37	504	1168	350	370	800	773	13	368	130	4.5	4.5	M12	-	108																
0211	55	45															504	1168	350	370	800	773	13	368	130	4.5	4.5	M12	-	108		
0250	75	55	504	1168	350	370	800	773	13	368	130	4.5	4.5	M12	-	108																
0312	90	75															504	1168	350	370	800	773	13	368	130	4.5	4.5	M12	-	108		
0360	110	90	504	1168	350	370	800	773	13	368	130	4.5	4.5	M12	-	108																

### 400 V Class

Model CIMR-AA4A	Max. Applicable Motor Capacity (kW)		Figure	Dimensions (mm)												Weight (kg)	Cooling														
	Normal Duty	Heavy Duty		W	H	D	W1	H0	H1	H2	H3	D1	t1	t2	d																
0002	0.75	0.4	1	140	260	147	122	-	248	6	-	38	5	-	M5	3.2	Self cooling														
0004	1.5	0.75																3.4													
0005	2.2	1.5																	164												
0007	3.0	2.2																167													
0009	3.7	3.0																	122	-	248	6	-	55	5	-	-	-	-	-	-
0011	5.5	3.7																180													
0018	7.5	5.5																	220	350	197	192	-	335	8	-	78	5	-	-	-
0023	11	7.5																220													
0031	15	11																	254	465	258	195	400	385	7.5	65	100	2.3	-	-	-
0038	18.5	15																279													
0044	22	18.5	329	630	258	260	510	495	7.5	120	105	2.3	3.2	-	-	39															
0058	30	22															456	730	283	260	550	535	7.5	180	110	2.3	3.2	-	-	45	
0072	37	30	504	960	330	325	705	680	12.5	255	130	3.2	3.2	M10	-	46															
0088	45	37															504	960	330	325	705	680	12.5	255	130	3.2	3.2	M10	-	87	
0103	55	45	504	960	330	325	705	680	12.5	255	130	3.2	3.2	M10	-	106															
0139	75	55															504	960	330	325	705	680	12.5	255	130	3.2	3.2	M10	-	112	
0165	90	75	504	960	330	325	705	680	12.5	255	130	3.2	3.2	M10	-	112															
0208	110	90															504	960	330	325	705	680	12.5	255	130	3.2	3.2	M10	-	112	
0250	132	110	504	960	330	325	705	680	12.5	255	130	3.2	3.2	M10	-	112															
0296	160	132															504	960	330	325	705	680	12.5	255	130	3.2	3.2	M10	-	112	
0362	185	160	504	960	330	325	705	680	12.5	255	130	3.2	3.2	M10	-	117															

■ Open-Chassis (IP00)

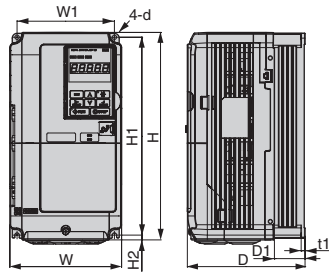

Figure 1

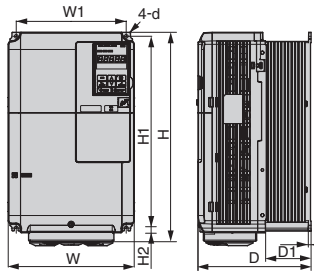

Figure 2

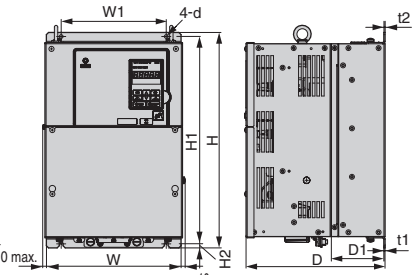

Figure 3

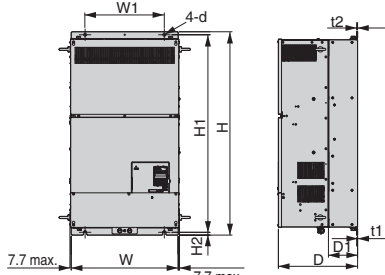

Figure 4

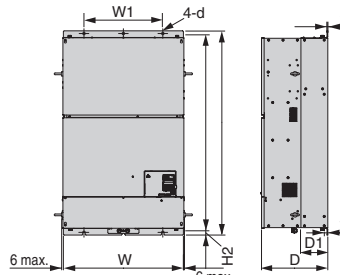

Figure 5

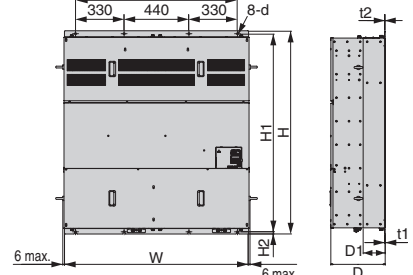

Figure 6

200 V Class

Model	Max. Applicable Motor Capacity (kW)		Figure	Dimensions (mm)										Weight (kg)	Cooling																					
	CIMR-AA2A	Normal Duty		Heavy Duty	W	H	D	W1	H1	H2	D1	t1	t2			d																				
0004	0.75	0.4	1	140	260	147	122	248	6	38	5	-	M5	3.1	Self cooling																					
0006	1.1	0.75												3.2																						
0008	1.5	1.1												140		260	164	122	248	6	55	5	-	M5	3.5	Fan cooled										
0010	2.2	1.5																							4											
0012	3	2.2																							167		160	284	8	75	5	-	-	M6	5.6	
0018	3.7	3																																	8.7	
0021	5.5	3.7																							180		300	187	160	284	8	75	5	-	M6	9.7
0030	7.5	5.5																																		21
0040	11	7.5																							220		350	197	192	335	8	78	5	-	M6	25
0056	15	11																																		37
0069	18.5	15	220	365	197	192	335	8	78	5	-	M6	38																							
0081	22	18.5											76																							
0110	30	22	250	400	258	195	385	7.5	100	2.3	2.3	M6	80																							
0138	37	30											98																							
0169	45	37	325	550	283	260	535	7.5	110	2.3	2.3	M6	99																							
0211	55	45											99																							
0250	75	55	450	705	330	325	680	12.5	130	3.2	3.2	M10	76																							
0312	90	75											80																							
0360	110	90	500	800	350	370	773	13	130	4.5	4.5	M12	80																							
0415	110	110											99																							

400 V Class

Model	Max. Applicable Motor Capacity (kW)		Figure	Dimensions (mm)										Weight (kg)	Cooling																					
	CIMR-AA4A	Normal Duty		Heavy Duty	W	H	D	W1	H1	H2	D1	t1	t2			d																				
0002	0.75	0.4	1	140	260	147	122	248	6	38	5	-	M5	3.2	Self cooling																					
0004	1.5	0.75												3.4																						
0005	2.2	1.5												140		260	164	122	248	6	55	5	-	M5	3.5	Fan cooled										
0007	3	2.2																							167		160	284	8	75	5	-	-	M6	5.4	
0009	3.7	3																																	5.7	
0011	5.5	3.7																							180		300	187	160	284	8	75	5	-	M6	8.3
0018	7.5	5.5																																		21
0023	11	7.5																							220		350	197	192	335	8	78	5	-	M6	25
0031	15	11																																		36
0038	18.5	15																							250		400	258	195	385	7.5	100	2.3	2.3	M6	41
0044	22	18.5	42																																	
0058	30	22	275	450	258	220	435	7.5	105	2.3	3.2	M6	79																							
0072	37	30											96																							
0088	45	37	325	510	258	260	495	7.5	110	2.3	3.2	M6	102																							
0103	55	45											107																							
0139	75	55	325	550	283	260	535	7.5	110	2.3	3.2	M6	125																							
0165	90	75											221																							
0208	110	90	450	705	330	325	680	12.5	130	3.2	3.2	M10	221																							
0250	132	110											545																							
0296	160	132	500	800	350	370	773	13	130	4.5	4.5	M12	555																							
0362	185	160											555																							
0414	220	185	500	950	370	370	923	13	135	4.5	4.5	M12	555																							
0515	250	220											555																							
0675	355	315	670	1140	370	440	1110	15	150	4.5	4.5	M12	555																							
0930	500	450											555																							
1200	630	560	1250	1380	370	1100	1345	15	150	4.5	4.5	M12	555																							
													555																							





## Attachment for External Heatsink

Additional attachments are required to install the following models: CIMR-AA2A0004 to 0081, CIMR-AA4A0002 to 0044. The final product will be wider and taller than the drive. Additional attachments are required for CIMR-AA2A0110 and above, CIMR-AA4A0058 and above.

Note: Contact Yaskawa for information on attachments for earlier models.

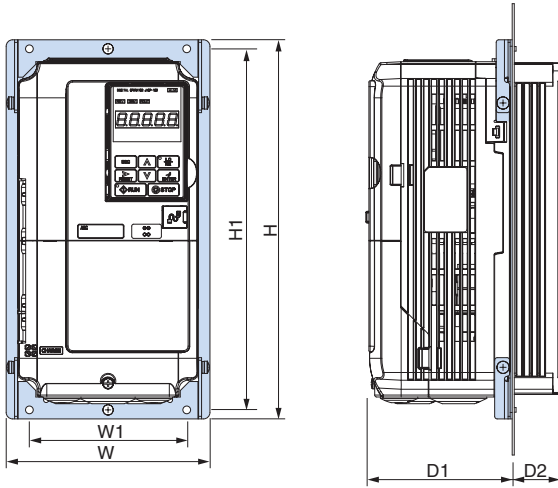

## 200 V Class

Model CIMR-AA2A:.....	Dimension (mm)						Code No.	
	W	H	W1	H1	D1	D2		
2A0004	158	294	122	280	109	36.4	EZZ020800A	
2A0006								
2A0008								
2A0010								
2A0012					109	53.4		EZZ020800B
2A0018								
2A0021								
2A0030					112	53.4		
2A0040								
2A0056					198	329		
2A0069	238	380	192	362	119	76.4	EZZ020800D	
2A0081								

## 400 V Class

Model CIMR-AA4A:.....	Dimension (mm)						Code No.	
	W	H	W1	H1	D1	D2		
4A0002	158	294	122	280	109	36.4	EZZ020800A	
4A0004								
4A0005								
4A0007								
4A0009					109	53.4		EZZ020800B
4A0011								
4A0018								
4A0023					112	53.4		
4A0031								
4A0038					198	329		
4A0044	238	380	192	362	119	76.4	EZZ020800D	

## Panel Modification for External Heatsink

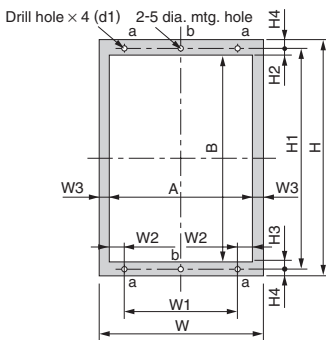

Modification Figure 1

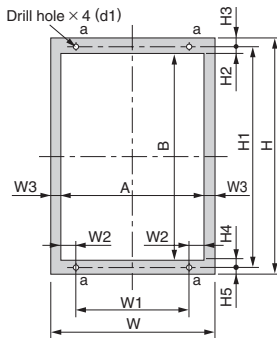

Modification Figure 2

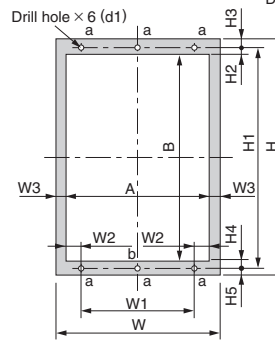

Modification Figure 3

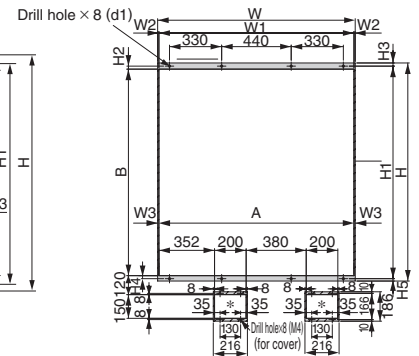

Modification Figure 4

\* Panel opening needed to replace an air filter installed to the bottom of the drive. The opening should be kept as small as possible.

## 200 V Class

Model CIMR-AA:.....	Modification Figure	Dimensions (mm)																									
		W	H	W1	W2	W3	H1	H2	H3	H4	H5	A	B	d1													
2A0004	1	158	294	122	9	9	280	8.5	8.5	7	-	140	263	M5													
2A0006																											
2A0008																											
2A0010																											
2A0012																											
2A0018																											
2A0021																											
2A0030																											
2A0040																											
2A0056															198	329	160	10	9	315	17.5	10.5	7	-	180	287	M5
2A0069	238	380	192	14	9	362	13	8	9	-	220	341															
2A0081																											
2A0110	2	250	400	195	19.5	8	385	8	7.5	8	7.5	234	369	M6													
2A0138															275	450	220		435						259	419	
2A0169															325	550	260	24.5	8	535	8	7.5	8	7.5	309	519	
2A0211																											
2A0250															450	705	325	54.5	8	680	12.5	12.5	12.5	12.5	434	655	M10
2A0312																											
2A0360															500	800	370	57	8	773	16	14	17	13	484	740	M12
2A0415																											

## 400 V Class



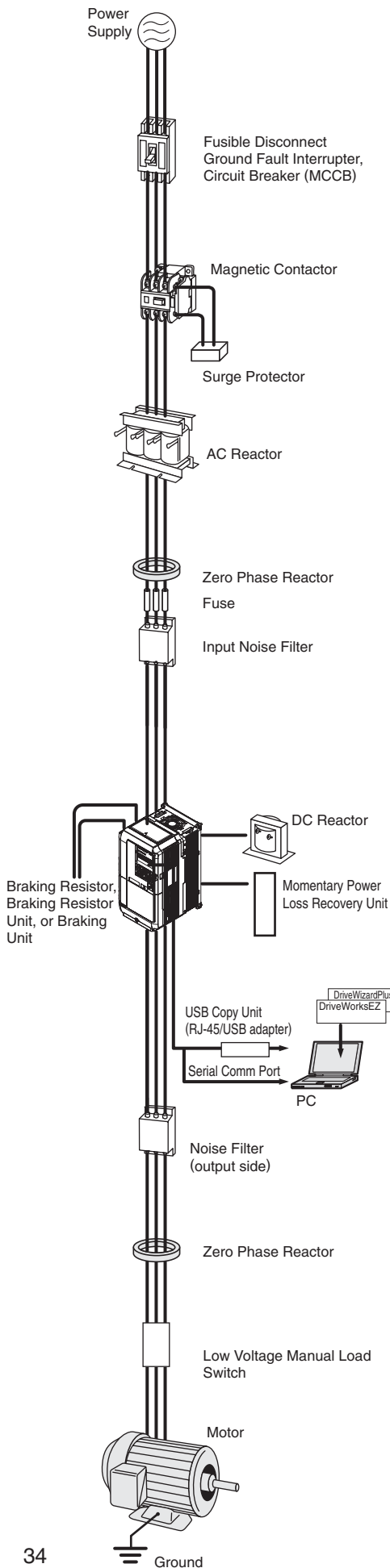







Model CIMR-AA:.....	Modification Figure	Dimensions (mm)																									
		W	H	W1	W2	W3	H1	H2	H3	H4	H5	A	B	d1													
4A0002	1	158	294	122	9	9	280	8.5	8.5	7	-	140	263	M5													
4A0004																											
4A0005																											
4A0007																											
4A0009																											
4A0011																											
4A0018																											
4A0023																											
4A0031															198	329	160	10	9	315	17.5	10.5	7	-	180	287	
4A0038															238	380	192	14	9	362	13	8	9	-	220	341	M6
4A0044																											
4A0058	2	250	400	195	19.5	8	385	8	7.5	8	7.5	234	369	M6													
4A0072															275	450	220		435						259	419	
4A0088															325	510	260	24.5	8	495	8	7.5	8	7.5	309	479	
4A0103																											
4A0139															325	550	260	24.5	8	535	8	7.5	8	7.5	309	519	
4A0165																											
4A0208															450	705	325	54.5	8	680	12.5	12.5	12.5	12.5	434	655	M10
4A0250																											
4A0296															500	800	370	57	8	773	16	14	17	13	484	740	M12
4A0362																											
4A0414	500	950	370	57	8	923	16	14	17	13	484	890	M12														
4A0515	3	670	1140	440	107	8	1110	19	15	19	15	654	1072	M12													
4A0675																											
4A0930	4	1250	1380	1100	67	8	1345	19	20	19	15	1234	1307	M12													
4A1200																											



Name	Purpose	Model, Manufacturer	Page
Ground Fault Interrupter (GFI)	Protects the drive from ground faults that could otherwise result in electric shock or fire. Choose a GFI designed to minimize harmonics specifically for AC drives. Use one GFI per drive, each with a current rating of at least 30 mA.	Recommended: NV series by Mitsubishi Electric Corporation NS Series by Schneider Electric	36
Circuit Breaker	Protects circuitry from excessive current. A circuit breaker should be installed between the main power supply and an AC reactor.	Recommended: NF series by Mitsubishi Electric Corporation	36
Magnetic Contactor	Interrupts the power supply to the drive. In addition to protecting drive circuitry, a magnetic contactor also prevents damage to a braking resistor if used.	Recommended: SC series by Fuji Electric FA Components & Systems Co., Ltd	37
Surge Protector	Absorbs the voltage surge from switching of electro-magnetic contactors and control relays. Install a surge protector to the magnetic contactors and control relays as well as magnetic valves and magnetic braking coil.	DCR2 series RFN series by Nippon Chemicon Corporation	37
DC Reactor	Improve the input power ratio of the drive. The DC reactor is a built-in model of 22 kW or more. Option: 18.5 kW or less.	UZDA series	38
AC Reactor	Used for harmonic current suppression and total improving power factor. Should be used if the power supply capacity is larger than 600 kVA. Suppresses harmonic current Improves the power factor of the input power supply	UZBA series	40
Zero Phase Reactor	Reduces noise from the line that enters into the drive input power system. Should be installed as close as possible to the drive. Can be used on both the input and output sides.	F6045GB F11080GB by Hitachi Metals, Ltd.	42
Fuse / Fuse Holder	Protects internal circuitry in the event of component failure. Fuse should be connected to the input terminal of the drive. Note: Refer to the instruction manual for information on UL approval.	CR2LS series CR6L series CM, CMS series by Fuji Electric FA Components & Systems Co., Ltd	43
Capacitor-Type Noise Filter	Reduces noise from the line that enters into the drive input power system. The noise filter can be used in combination with a zero-phase reactor. Note: Available for drive input only. Do not connect the noise filter to the output terminals.	3XYG 1003 by Okaya Electric Industries Co., Ltd.	43
Input Noise Filter	Reduces noise from the line that enters into the drive input power system. Should be installed as close as possible to the drive. Note: For CE Marking (EMC Directive) compliant models, refer to A1000 Technical Manual.	LNFD series LNFB series FN series	44
Output Noise Filter	Reduces noise from the line that enters into the drive input power system. Should be installed as close as possible to the drive.	LF series by NEC Tokin Corporation	46
Braking Resistor	Used to shorten the deceleration time by dissipating regenerative energy through a resistor. Usage 3% ED, requires a separate attachment.	ERF-150WJ series CF120-B579 series	48
Attachment for Braking Resistor	A braking resistor can be attached to the drive.	EZZ020805A	51
Braking Resistor Unit	Used to shorten the deceleration time by dissipating regenerative energy through a resistor unit (10% ED). A thermal overload relay is built in (10% ED).	LKEB series	48
Braking Unit	Shortened deceleration time results when used with a Braking Resistor Unit.	CDBR series	48
24 V Power Supply	Provides power supply for the control circuit and option boards. Note: Parameter settings cannot be changed when the drive is operating solely from this power supply.	PS-A10H PS-A10L	47
VS System Module	System control device that enables optimum system configuration by combining modules for automatic control system.	JGSM series	52
USB Copy Unit (RJ-45/USB compatible plug)	Can copy parameter settings easily and quickly to be later transferred to another drive. Adapter for connecting the drive to the USB port of a PC	JVOP-181	55
Support Tools USB Cable	Connect the drive and PC when using DriveWizard or DriveWorksEZ. The cable length must be 3 m or less.	Commercially available USB2.0 A/B cable.	—
LCD Operator	For easier operation when using the optional LCD operator. Allows for remote operation. Includes a Copy function for saving drive settings.	JVOP-180	54
LCD Operator Extension Cable	Cable for connecting the LCD operator.	WV001: 1 m WV003: 3 m	54
Momentary Power Loss Recovery Unit	Ensures continuous drive operation for a power loss of up to 2 s.	P0010 Type (200 V class) P0020 Type (400 V class)	47
Frequency Meter, Current Meter Variable Resistor Board (20 kΩ) Frequency Setting Potentiometer (2 kΩ) Frequency Meter Adjusting Potentiometer (20 kΩ) Control Dial for Frequency Setting Potentiometer Output Voltage Meter Voltage Transformer	Allows the user to set and monitor the frequency, current, and voltage using an external device.	DCF-6A ETX003120 RH000739 RH000850 CM-3S SCF-12NH UPN-B	56 56 56 56 56 57
Attachment for External Heatsink	Required for heatsink installation. Current derating may be needed when using a heatsink.	—	33
Low Voltage Manual Load Switch	Prevents shock from the voltage created on the terminals board from a coasting synchronous motor.	Recommended: AICUT, LB series by Aichi Electric Works Co., Ltd	—

Note: Contact the manufacturer in question for availability and specifications of non-Yaskawa products.

## Option Cards

Type	Name	Model	Function	Manual No.
Speed Reference Card	Analog Input 	AI-A3	Enables high-precision and high-resolution analog speed reference setting. · Input signal level: –10 to +10 Vdc (20 kΩ) 4 to 20 mA (500 Ω) · Input channels: 3 channels, DIP switch for input voltage/input current selection · Input resolution: Input voltage 13 bit signed (1/8192) Input current 1/6554	TOBPC73060038
	Digital Input 	DI-A3	Enables 16-bit digital speed reference setting. · Input signal: 16 bit binary, 2 digit BCD + sign signal + set signal · Input voltage: +24 V (isolated) · Input current: 8 mA User-set: 8 bit, 12 bit, 16 bit	TOBPC73060039
Communications Option Card	DeviceNet Interface 	SI-N3	Used for running or stopping the drive, setting or referencing parameters, and monitoring output frequency, output current, or similar items through DeviceNet communication with the host controller.	TOBPC73060043 SIEPC73060043
	CC-Link Interface 	SI-C3	Used for running or stopping the drive, setting or referencing parameters, and monitoring output frequency, output current, or similar items through CC-Link communication with the host controller.	TOBPC73060044 SIEPC73060044
	PROFIBUS-DP Interface 	SI-P3	Used for running or stopping the drive, setting or referencing parameters, and monitoring output frequency, output current, or similar items through CANopen communication with the host controller.	TOBPC73060042 SIEPC73060042
	CANopen Interface 	SI-S3	Used for running or stopping the drive, setting or referencing parameters, and monitoring output frequency, output current, or similar items through CANopen communication with the host controller.	TOBPC73060045 SIEPC73060045
	MECHATROLINK-II Interface SI-T3 	SI-T3	Used for running or stopping the drive, setting or referencing parameters, and monitoring output frequency, output current, or similar items through MECHATROLINK-II communication with the host controller.	TOBPC73060050 SIEPC73060050
	LONWORKS Interface	Available soon	Used for HVAC control, running or stopping the drive, setting or referencing parameters, and monitoring output current, watt-hours, or similar items through LONWORKS communications with the host controller.	–
	Monitor Option Card	Analog Monitor 	AO-A3	Outputs analog signal for monitoring drive output state (output freq., output current etc.). · Output resolution: 11 bit signed (1/2048) · Output voltage: –10 to +10 Vdc (non-isolated) · Terminals: 2 analog outputs
Digital Output 		DO-A3	Outputs isolated type digital signal for monitoring drive run state (alarm signal, zero speed detection, etc.) · Terminals: 6 photocoupler outputs (48 V, 50 mA or less) 2 relay contact outputs (250 Vac, 1 A or less 30 Vdc, 1 A or less)	TOBPC73060041
PG Speed Controller Card	Complimentary Type PG 	PG-B3	For control modes requiring a PG encoder for motor feedback. · Phase A, B, and Z pulse (3-phase) inputs (complementary type) · Max. input frequency: 50 kHz · Pulse monitor output: Open collector, +24 V, max. current 30 mA · Power supply output for PG: +12 V, max. current 200 mA	TOBPC73060036
	Line Driver PG 	PG-X3	For control modes requiring a PG encoder for motor feedback. · Phase A, B, and Z pulse (differential pulse) inputs (RS-422) · Max. input frequency: 300 kHz · Pulse monitor output: RS-422 · Power supply output for PG: +5 V or +12 V, max. current 200 mA	TOBPC73060037

Note: 1. Each communication option card requires a separate configuration file to link to the network.  
2. PG speed controller card is required for PG control.

### ● Ground Fault Interrupter, Circuit Breaker

Base device selection on motor capacity.



Ground Fault Interrupter  
【Mitsubishi Electric Corporation】



Circuit Breaker  
【Mitsubishi Electric Corporation】

#### 200 V Class

Motor Capacity (kW)	Ground Fault Interrupter						Circuit Breaker					
	Without Reactor			With Reactor			Without Reactor			With Reactor		
	Model	Rated Current (A)	Interrupt Capacity (kA) Icu/Ics*	Model	Rated Current (A)	Interrupt Capacity (kA) Icu/Ics*	Model	Rated Current (A)	Interrupt Capacity (kA) Icu/Ics*	Model	Rated Current (A)	Interrupt Capacity (kA) Icu/Ics*
0.4	NV32-SW	5	10/5	NV32-SW	5	10/5	NF32	5	7.5/4	NF32	5	7.5/4
0.75	NV32-SW	10	10/5	NV32-SW	10	10/5	NF32	10	7.5/4	NF32	10	7.5/4
1.5	NV32-SW	15	10/5	NV32-SW	10	10/5	NF32	15	7.5/4	NF32	10	7.5/4
2.2	NV32-SW	20	10/5	NV32-SW	15	10/5	NF32	20	7.5/4	NF32	15	7.5/4
3.7	NV32-SW	30	10/5	NV32-SW	20	10/5	NF32	30	7.5/4	NF32	20	7.5/4
5.5	NV63-SW	50	15/8	NV63-SW	40	15/8	NF63	50	7.5/4	NF63	40	7.5/4
7.5	NV125-SW	60	50/25	NV63-SW	50	15/8	NF125	60	30/15	NF63	50	7.5/4
11	NV125-SW	75	50/25	NV125-SW	75	50/25	NF125	75	30/15	NF125	75	30/15
15	NV250-SW	125	50/25	NV125-SW	100	50/25	NF250	125	35/18	NF125	100	30/15
18.5	NV250-SW	150	50/25	NV250-SW	125	50/25	NF250	150	35/18	NF250	125	35/18
22	—	—	—	NV250-SW	150	50/25	—	—	—	NF250	150	35/18
30	—	—	—	NV250-SW	175	50/25	—	—	—	NF250	175	35/18
37	—	—	—	NV250-SW	225	50/25	—	—	—	NF250	225	35/18
45	—	—	—	NV400-SW	250	85/85	—	—	—	NF400	250	50/25
55	—	—	—	NV400-SW	300	85/85	—	—	—	NF400	300	50/25
75	—	—	—	NV400-SW	400	85/85	—	—	—	NF400	400	50/25
90	—	—	—	NV630-SW	500	85/85	—	—	—	NF630	500	50/25
110	—	—	—	NV630-SW	600	85/85	—	—	—	NF630	600	50/25

\*: Icu: Rated ultimate short-circuit breaking capacity Ics: Rated service short-circuit breaking capacity  
Note: 200 V models 22 kW and above come with a built-in DC reactor that improves the power factor.

#### 400 V Class

Motor Capacity (kW)	Ground Fault Interrupter						Circuit Breaker					
	Without Reactor			With Reactor			Without Reactor			With Reactor		
	Model	Rated Current (A)	Interrupt Capacity (kA) Icu/Ics*1	Model	Rated Current (A)	Interrupt Capacity (kA) Icu/Ics*1	Model	Rated Current (A)	Interrupt Capacity (kA) Icu/Ics*1	Model	Rated Current (A)	Interrupt Capacity (kA) Icu/Ics*1
0.4	NV32-SW	5	5/2	NV32-SW	5	5/2	NF32	3	2.5/1	NF32	3	2.5/1
0.75	NV32-SW	5	5/2	NV32-SW	5	5/2	NF32	5	2.5/1	NF32	5	2.5/1
1.5	NV32-SW	10	5/2	NV32-SW	10	5/2	NF32	10	2.5/1	NF32	10	2.5/1
2.2	NV32-SW	15	5/2	NV32-SW	10	5/2	NF32	15	2.5/1	NF32	10	2.5/1
3.7	NV32-SW	20	5/2	NV32-SW	15	5/2	NF32	20	2.5/1	NF32	15	2.5/1
5.5	NV32-SW	30	5/2	NV32-SW	20	5/2	NF32	30	2.5/1	NF32	20	2.5/1
7.5	NV32-SW	30	5/2	NV32-SW	30	5/2	NF32	30	2.5/1	NF32	30	2.5/1
11	NV63-SW	50	7.5/4	NV63-SW	40	7.5/4	NF63	50	2.5/1	NF63	40	2.5/1
15	NV125-SW	60	25/13	NV63-SW	50	7.5/4	NF125	60	10/5	NF63	50	2.5/1
18.5	NV125-SW	75	25/13	NV125-SW	60	25/13	NF125	75	10/5	NF125	60	10/5
22	—	—	—	NV125-SW	75	25/13	—	—	—	NF125	75	10/5
30	—	—	—	NV125-SW	100	25/13	—	—	—	NF125	100	10/5
37	—	—	—	NV250-SW	125	25/13	—	—	—	NF250	125	18/9
45	—	—	—	NV250-SW	150	25/13	—	—	—	NF250	150	18/9
55	—	—	—	NV250-SW	175	25/13	—	—	—	NF250	175	18/9
75	—	—	—	NV250-SW	225	25/13	—	—	—	NF250	225	18/9
90	—	—	—	NV400-SW	250	42/42	—	—	—	NF400	250	25/13
110	—	—	—	NV400-SW	300	42/42	—	—	—	NF400	300	25/13
132	—	—	—	NV400-SW	350	42/42	—	—	—	NF400	350	25/13
160	—	—	—	NV400-SW	400	42/42	—	—	—	NF400	400	25/13
185	—	—	—	NV630-SW	500	42/42	—	—	—	NF630	500	36/18
220	—	—	—	NV630-SW	630	42/42	—	—	—	NF630	630	36/18
250	—	—	—	NV630-SW	630	42/42	—	—	—	NF630	630	36/18
315	—	—	—	NV800-SEW	800	42/42	—	—	—	NF800	800	36/18
355	—	—	—	NV800-SEW	800	42/42	—	—	—	NF800	800	36/18
450	—	—	—	NV1000-SB	1000	85	—	—	—	NF1000	1000	85/43
500	—	—	—	NV1200-SB	1200	85	—	—	—	NF1250	1250	85/43
560	—	—	—	NS1600H*2	1600	70	—	—	—	NF1600	1600	85/43
630	—	—	—	NS1600H*2	1600	70	—	—	—	NF1600	1600	85/43

\*1: Icu: Rated ultimate short-circuit breaking capacity Ics: Rated service short-circuit breaking capacity  
\*2: NS series by Schneider Electric.

Note: 400 V models 22 kW and above come with a built-in DC reactor that improves the power factor.

## ● Magnetic Contactor

Base device selection on motor capacity.

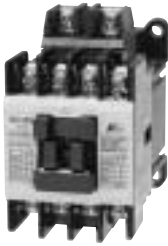

**Magnetic Contactor**  
[Fuji Electric FA Components & Systems Co., Ltd]

### Wiring a Magnetic Contactor in Parallel

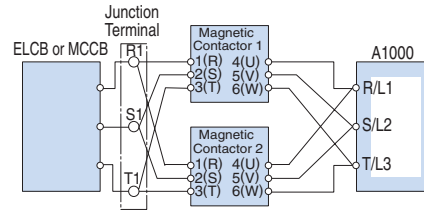

Note: When wiring contactors in parallel, make sure wiring lengths are the same to keep current flow even to the relay terminals.

### 200 V Class

Motor Capacity (kW)	Without Reactor		With Reactor	
	Model	Rated Current (A)	Model	Rated Current (A)
0.4	SC-03	11	SC-03	11
0.75	SC-05	13	SC-03	11
1.5	SC-4-0	18	SC-05	13
2.2	SC-N1	26	SC-4-0	18
3.7	SC-N2	35	SC-N1	26
5.5	SC-N2S	50	SC-N2	35
7.5	SC-N3	65	SC-N2S	50
11	SC-N4	80	SC-N4	80
15	SC-N5	93	SC-N4	80
18.5	SC-N5	93	SC-N5	93
22	—	—	SC-N6	125
30	—	—	SC-N7	152
37	—	—	SC-N8	180
45	—	—	SC-N10	220
55	—	—	SC-N11	300
75	—	—	SC-N12	400
90	—	—	SC-N12	400
110	—	—	SC-N14	600

Note: 200 V models 22 kW and above come with a built-in DC reactor that improves the power factor.

### 400 V Class

Motor Capacity (kW)	Without Reactor		With Reactor	
	Model	Rated Current (A)	Model	Rated Current (A)
0.4	SC-03	7	SC-03	7
0.75	SC-03	7	SC-03	7
1.5	SC-05	9	SC-05	9
2.2	SC-4-0	13	SC-4-0	13
3.7	SC-4-1	17	SC-4-1	17
5.5	SC-N2	32	SC-N1	25
7.5	SC-N2S	48	SC-N2	32
11	SC-N2S	48	SC-N2S	48
15	SC-N3	65	SC-N2S	48
18.5	SC-N3	65	SC-N3	65
22	—	—	SC-N4	80
30	—	—	SC-N4	80
37	—	—	SC-N5	90
45	—	—	SC-N6	110
55	—	—	SC-N7	150
75	—	—	SC-N8	180
90	—	—	SC-N10	220
110	—	—	SC-N11	300
132	—	—	SC-N11	300
160	—	—	SC-N12	400
185	—	—	SC-N12	400
220	—	—	SC-N14	600
250	—	—	SC-N14	600
315	—	—	SC-N16	800
355	—	—	SC-N16	800
450	—	—	SC-N14 × 2*1	600*2
500	—	—	SC-N14 × 2*1	600*2
560	—	—	SC-N16 × 2*1	800*2
630	—	—	SC-N16 × 2*1	800*2

\*1 : When two units are connected in parallel.

\*2 : Rated current for a single unit.

Note: 400 V models 22 kW and above come with a built-in DC reactor that improves the power factor.

## ● Surge Protector

Dimensions (mm)

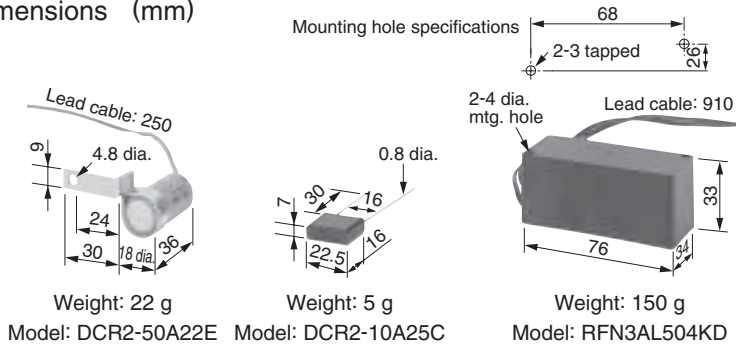

[Nippon Chemi-Con Corporation]

### Product Line

Peripheral Devices		Surge Protector	Model	Specifications	Code No.
200 to 230 V	Control Relay	Large-Capacity Coil (other than relay)	DCR2-50A22E	220 Vac 0.5 $\mu$ F+200 $\Omega$	C002417
		MY2, MY3 [Omron Corporation]	DCR2-10A25C	250 Vac 0.1 $\mu$ F+100 $\Omega$	C002482
		MM2, MM4 [Omron Corporation]			
		HH22, HH23 [Fuji Electric FA Components & Systems Co., Ltd]	RFN3AL504KD	1000 Vdc 0.5 $\mu$ F+220 $\Omega$	C002630
		380 to 460 V			

Peripheral Devices and Options

### DC Reactor (UZDA-B for DC circuit)

Base device selection on motor capacity.

Lead Wire Type

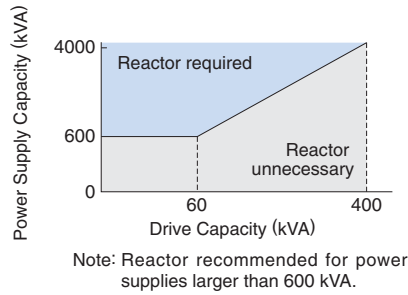
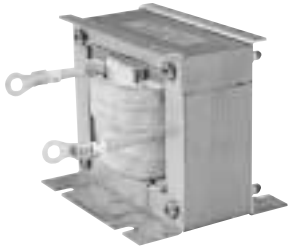

Connection Diagram

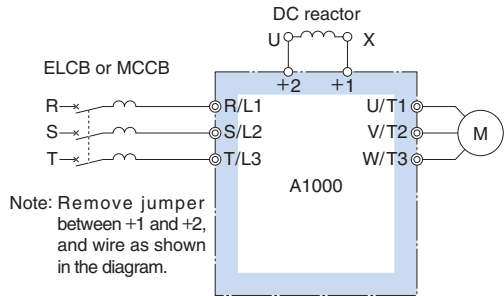

Dimensions (mm)

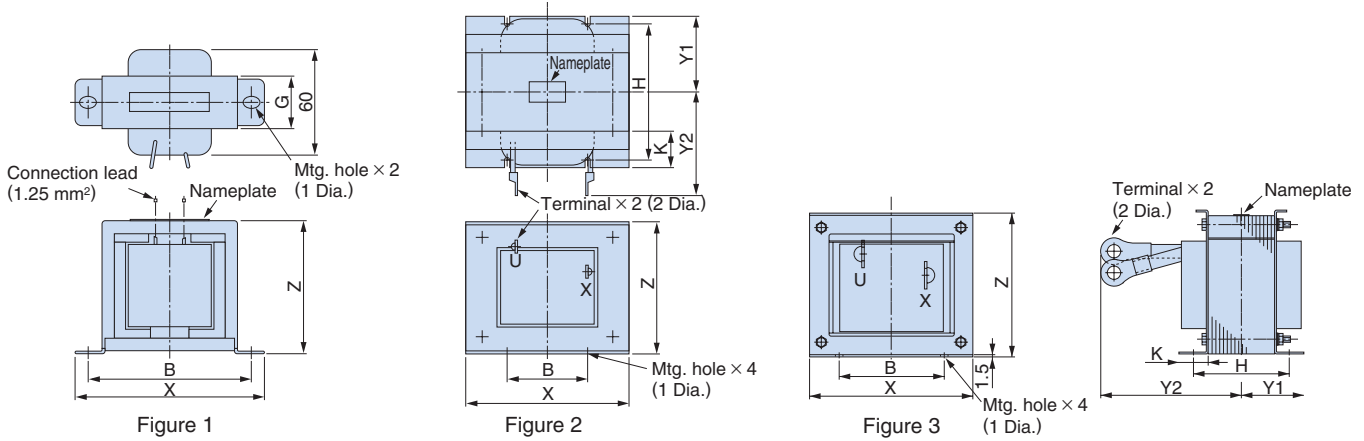

### 200 V Class

Motor Capacity (kW)	Current (A)	Inductance (mH)	Code No.	Figure	Dimensions (mm)								Weight (kg)	Watt Loss (W)	Wire Gauge*1 (mm <sup>2</sup> )		
					X	Y2	Y1	Z	B	H	K	G				1 Dia.	2 Dia.
0.4	5.4	8	X010048	1	85	—	—	53	74	—	—	32	M4	—	0.8	8	2
0.75	5.4	8	X010048	1	85	—	—	53	74	—	—	32	M4	—	0.8	8	2
1.5	18	3	X010049	2	86	80	36	76	60	55	18	—	M4	M5	2	18	5.5
2.2	18	3	X010049	2	86	80	36	76	60	55	18	—	M4	M5	2	18	5.5
3.7	18	3	X010049	2	86	80	36	76	60	55	18	—	M4	M5	2	18	5.5
5.5	36	1	X010050	2	105	90	46	93	64	80	26	—	M6	M6	3.2	22	8
7.5	36	1	X010050	2	105	90	46	93	64	80	26	—	M6	M6	3.2	22	8
11	72	0.5	X010051	2	105	105	56	93	64	100	26	—	M6	M8	4.9	29	30
15	72	0.5	X010051	2	105	105	56	93	64	100	26	—	M6	M8	4.9	29	30
18.5	90	0.4	X010176	2	133	120	52.5	117	86	80	25	—	M6	M8	6.5	45	30
22*2	105	0.3	300-028-140	3	133	120	52.5	117	86	80	25	—	M6	M10	8	55	50
22 to 110	Built-in																

\*1: Cable: Indoor PVC (75°C), ambient temperature 45°C, 3 lines max.

\*2: Select a motor of this capacity when using a CIMR-AA2A0081.

### 400 V Class

Motor Capacity (kW)	Current (A)	Inductance (mH)	Code No.	Figure	Dimensions (mm)								Weight (kg)	Watt Loss (W)	Wire Gauge*1 (mm <sup>2</sup> )		
					X	Y2	Y1	Z	B	H	K	G				1 Dia.	2 Dia.
0.4	3.2	28	X010052	1	85	—	—	53	74	—	—	32	M4	—	0.8	9	2
0.75	3.2	28	X010052	1	85	—	—	53	74	—	—	32	M4	—	0.8	9	2
1.5	5.7	11	X010053	1	90	—	—	60	80	—	—	32	M4	—	1	11	2
2.2	5.7	11	X010053	1	90	—	—	60	80	—	—	32	M4	—	1	11	2
3.7	12	6.3	X010054	2	86	80	36	76	60	55	18	—	M4	M5	2	16	2
5.5	23	3.6	X010055	2	105	90	46	93	64	80	26	—	M6	M5	3.2	27	5.5
7.5	23	3.6	X010055	2	105	90	46	93	64	80	26	—	M6	M5	3.2	27	5.5
11	33	1.9	X010056	2	105	95	51	93	64	90	26	—	M6	M6	4	26	8
15	33	1.9	X010056	2	105	95	51	93	64	90	26	—	M6	M6	4	26	8
18.5	47	1.3	X010177	2	115	125	57.5	100	72	90	25	—	M6	M6	6	42	14
22*2	56	1	300-028-141	3	133	105	52.5	117	86	80	25	—	M6	M6	7	50	22
22 to 630	Built-in																

\*1: Cable: Indoor PVC (75°C), ambient temperature 45°C, 3 lines max.

\*2: Select a motor of this capacity when using a CIMR-AA4A0044.



### Terminal Type



### Dimensions (mm)

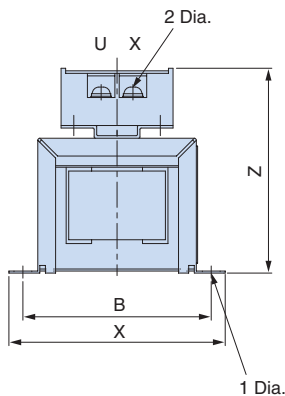

Figure 1

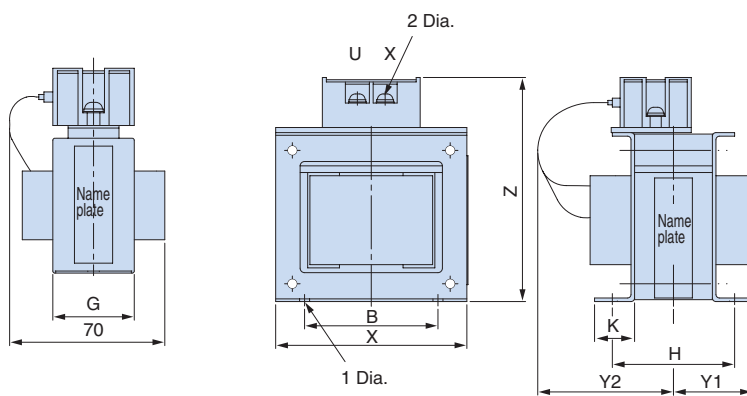

Figure 2

### 200 V Class

Motor Capacity (kW)	Current (A)	Inductance (mH)	Code No.	Figure	Dimensions (mm)										Weight (kg)	Watt Loss (W)
					X	Y2	Y1	Z	B	H	K	G	1 Dia.	2 Dia.		
0.4	5.4	8	300-027-130	1	85	-	-	81	74	-	-	32	M4	M4	0.8	8
0.75																
1.5	18	3	300-027-131	2	86	84	36	101	60	55	18	-	M4	M4	2	18
2.2																
3.7																
5.5	36	1	300-027-132	2	105	94	46	129	64	80	26	-	M6	M4	3.2	22
7.5																
11	72	0.5	300-027-133	2	105	124	56	135	64	100	26	-	M6	M6	4.9	29
15																
18.5	90	0.4	300-027-139	2	133	147.5	52.5	160	86	80	25	-	M6	M6	6.5	44

### 400 V Class

Motor Capacity (kW)	Current (A)	Inductance (mH)	Code No.	Figure	Dimensions (mm)										Weight (kg)	Watt Loss (W)
					X	Y2	Y1	Z	B	H	K	G	1 Dia.	2 Dia.		
0.4	3.2	28	300-027-134	1	85	-	-	81	74	-	-	32	M4	M4	0.8	9
0.75																
1.5	5.7	11	300-027-135	1	90	-	-	88	80	-	-	32	M4	M4	1	11
2.2																
3.7	12	6.3	300-027-136	2	86	84	36	101	60	55	18	-	M4	M4	2	16
5.5																
7.5																
11	23	3.6	300-027-137	2	105	104	46	118	64	80	26	-	M6	M4	3.2	27
15																
18.5	33	1.9	300-027-138	2	105	109	51	129	64	90	26	-	M6	M4	4	26
18.5	47	1.3	300-027-140	2	115	142.5	57.5	136	72	90	25	-	M6	M5	6	42

### AC Reactor (UZBA-B for 50/60 Hz Input)

Base device selection on motor capacity.

Lead Wire Type



#### Connection Diagram

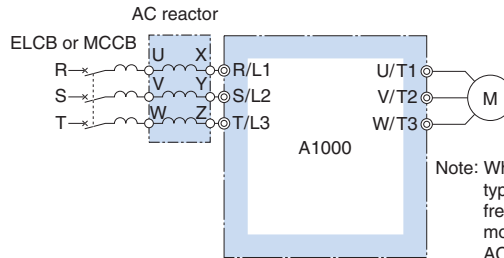

Note: When using low noise type drives (high-carrier frequency of 2.5 kHz or more), do not connect an AC reactor to the output side (U, V, W) of the drive.

#### Dimensions (mm)

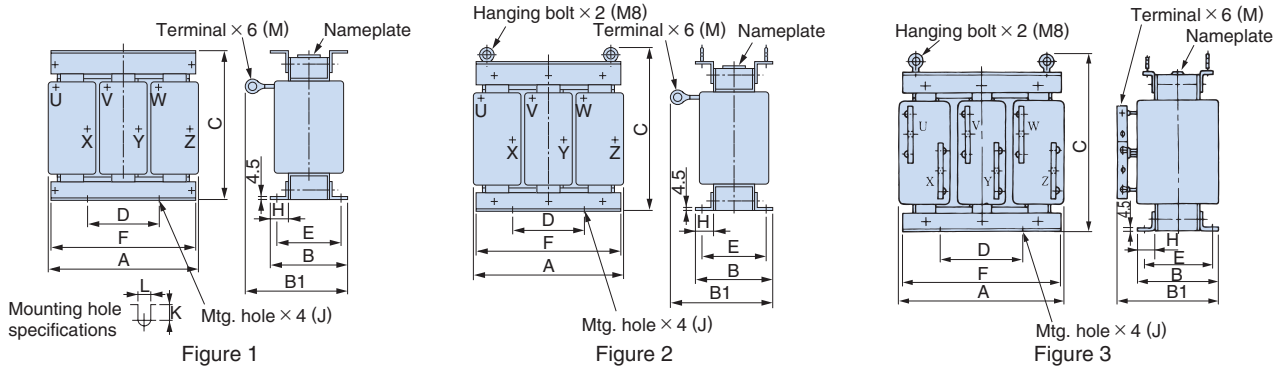

#### 200 V Class

Motor Capacity (kW)	Current (A)	Inductance (mH)	Code No.	Figure	Dimensions (mm)											Weight (kg)	Watt Loss (W)	
					A	B	B1	C	D	E	F	H	J	K	L			M
3.7	20	0.53	X002491	1	130	88	114	105	50	70	130	22	M6	11.5	7	M5	3	35
5.5	30	0.35	X002492				119							9			3	45
7.5	40	0.265	X002493				98							11.5			4	50
11	60	0.18	X002495		160	105	147.5	130	75	85	160	25	M6	10	7	M6	6	65
15	80	0.13	X002497				155										75	75
18.5	90	0.12	X002498		180	100	150	150	75	80	180	25	M6	10	7	M8	8	90
22	120	0.09	X002555				155										80	12
30	160	0.07	X002556		210	100	170	175	75	80	205	25	M6	10	7	M10	12	100
37	200	0.05	X002557				115										95	15
45	240	0.044	X002558		240	126	218	215±5	150	110	240	25	M6	8	7	M10	23	125
55	280	0.038	X002559										M8					
75	360	0.026	X002560		270	162	241	230±5	150	130	260	40	M8	16	10	M12	32	145
90	500	0.02	X010145															
110	500	0.02	X010145		2													

#### 400 V Class

Motor Capacity (kW)	Current (A)	Inductance (mH)	Code No.	Figure	Dimensions (mm)											Weight (kg)	Watt Loss (W)	
					A	B	B1	C	D	E	F	H	J	K	L			M
7.5	20	1.06	X002502	1	160	90	130	75	70	160	25	M6	10	7	M5	5	50	
11	30	0.7	X002503			105			85							6	65	
15	40	0.53	X002504		180	100	140	150	75	80	180	25	M6	10	7	M6	8	90
18.5	50	0.42	X002505				145										150	8.5
22	60	0.36	X002506		210	100	150	175	75	80	205	25	M6	10	7	M8	12	95
37	90	0.24	X002509				115										95	15
45	120	0.18	X002566		240	126	193	205±5	150	110	240	25	M8	8	10	M10	23	130
55	150	0.15	X002567				198											
75	200	0.11	X002568		270	162	231	230±5	150	130	260	40	M8	16	10	M10	32	135
90	250	0.09	X002569															
110	250	0.09	X002569		270	162	231	230±5	150	130	260	40	M8	16	10	M10	32	135
132	330	0.06	X002570															
160	330	0.06	X002570		320	165	253	230±5	150	130	320	40	M10	17.5	12	M12	55	200
185	490	0.04	X002690															
220	490	0.04	X002690	2														
250	490	0.04	X002690	330	216	353	315±5	150	185	320	40	M10	15.5	18	M16	80	310	
315	660	0.03	X002691															3
355	660	0.03	X002691	330	176	293	315±5	150	150	320	40	M10	13	12	M12	60	340	
450	490*1	0.04	X002690 × 2*2															2
500	490*1	0.04	X002690 × 2*2	330	216	353	315±5	150	185	320	40	M10	15.5	18	M16	80	310	
560	660*1	0.03	X002691 × 2*2															3
630	660*1	0.03	X002691 × 2*2	330	176	293	315±5	150	150	320	40	M10	13	12	M12	60	340	
			X002690 × 2*2															2

\*1: Rated current for a single unit.

\*2: When two units are connected in parallel.



## Terminal Type

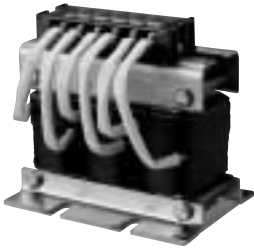

### Dimensions (mm)

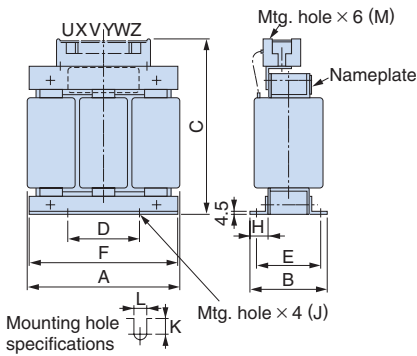

Figure 1

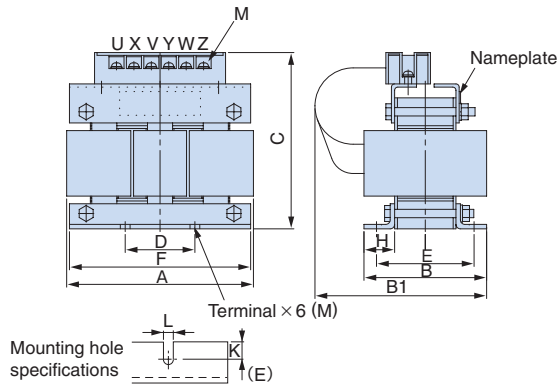

Figure 2

### 200 V Class

Motor Capacity (kW)	Current (A)	Inductance (mH)	Code No.	Figure	Dimensions (mm)											Weight (kg)	Watt Loss (W)							
					A	B	B1	C	D	E	F	H	J	K	L			M						
0.4	2.5	4.2	X002553	1	120	71	-	120	40	50	105	20	M6	10.5	7	M4	2.5	15						
0.75	5	2.1	X002554		130	88	-	130	50	70	130	22		11.5			3	25						
1.5	10	1.1	X002489		135	88	140	130	50	70	130	22		11.5	7		M5	3	30					
2.2	15	0.71	X002490															3	35					
3.7	20	0.53	300-027-120	2	135	98	160	140	50	80	130	22	11.5	7	M6	3	45							
5.5	30	0.35	300-027-121													9	45							
7.5	40	0.265	300-027-122													11.5	50							
11	60	0.18	300-027-123													10	65							
15	80	0.13	300-027-124													10	75	75	85	160	25	M6	6	65
18.5	90	0.12	300-027-125																				8	75
					185	100	180	195	75	80	180	25	10	M6	8	90								

### 400 V Class

Motor Capacity (kW)	Current (A)	Inductance (mH)	Code No.	Figure	Dimensions (mm)											Weight (kg)	Watt Loss (W)			
					A	B	B1	C	D	E	F	H	J	K	L			M		
0.4	1.3	18	X002561	1	120	71	-	120	40	50	105	20	M6	10.5	7	M4	2.5	15		
0.75	2.5	8.4	X002562		130	88	-	130	50	70	130	22		9			3	25		
1.5	5	4.2	X002563		130	88	140	130	50	70	130	22		11.5	7		M5	4	50	
2.2	7.5	3.6	X002564															98	4	50
3.7	10	2.2	X002500	2	165	105	175	155	75	70	160	25	11.5	7	M4	5	50			
5.5	15	1.42	X002501													80	5	50		
7.5	20	1.06	300-027-126													70	6	65		
11	30	0.7	300-027-127													85	6	65		
15	40	0.53	300-027-128													10	7	M5	6	65
18.5	50	0.42	300-027-129																8	90
					185	100	170	185	75	80	180	25	10	M5	8	90				

### Zero Phase Reactor

Zero-phase reactor should match wire gauge.\*

\* Current values for wire gauges may vary based on electrical codes.

The table below lists selections based on Japanese electrical standards and Yaskawa's ND rating. Contact Yaskawa for questions regarding UL.

#### Finemet Zero-Phase Reactor to Reduce Radio Noise

Note: Finemet is a registered trademark of Hitachi Metals, Ltd.



[Hitachi Metals, Ltd.]

#### Connection Diagram

Compatible with the input and output side of the drive.

Example: Connection to output terminal

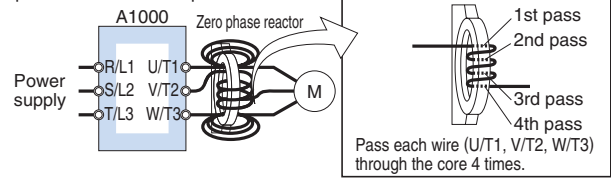
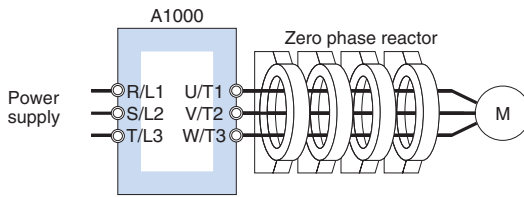
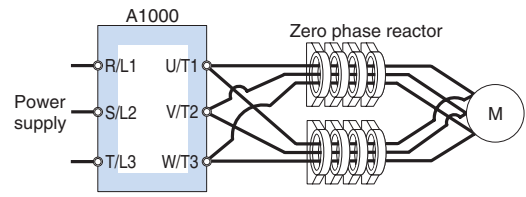

Diagram a



All wires (U/T1, V/T2, W/T3) should pass through the four cores of the reactor in series without winding.

Diagram b



Separate each terminal lead for U/T1, V/T2, and W/T3 in half, passing one half of the wires through a set of four cores and the other half through the other set of four cores as shown.

Diagram c

#### Dimensions (mm)

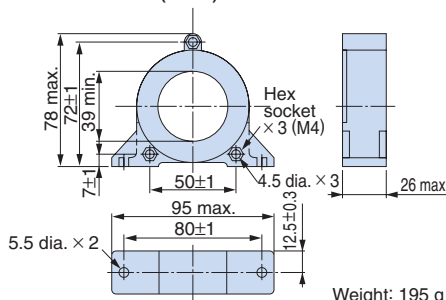

Model F6045GB

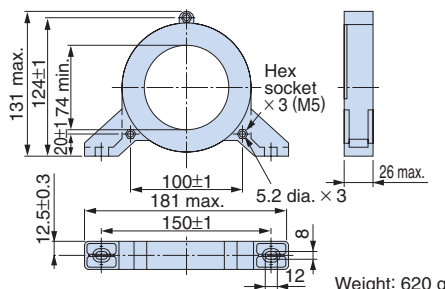

Model F11080GB

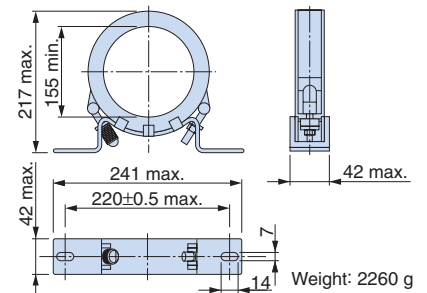

Model F200160PB

#### 200 V Class

Motor Capacity (kW)	A1000		Zero Phase Reactor								
	Recommended Gauge (mm <sup>2</sup> )		Input Side				Output Side				
	Input Side	Output Side	Model	Code No.	Qty.	Diagram	Model	Code No.	Qty.	Diagram	
0.4											
0.75	2	2	F6045GB	FIL001098	1	a	F6045GB	FIL001098	1	a	
1.5											
2.2											
3.7	3.5	3.5									
5.5	5.5	3.5									
7.5	8	8	F11080GB	FIL001097	1	a	F11080GB	FIL001097	1	a	
11	14	14	F6045GB	FIL001098	4	b	F6045GB	FIL001098	4	b	
15	22	14									
18.5	30	22									
22	38	30									
30	38	38									
37	60	60									
45	80	80	F11080GB	FIL001097	4	b	F11080GB	FIL001097	4	b	
55	100	80×2P									
75	80×2P	80×2P									
90	80×2P	80×2P	F200160PB	300-001-041							F200160PB
110	*	*									

\*Model 2A0360: 100 × 2P, model 2A0415: 125 × 2P

#### 400 V Class

Motor Capacity (kW)	A1000		Zero Phase Reactor							
	Recommended Gauge (mm <sup>2</sup> )		Input Side				Output Side			
	Input Side	Output Side	Model	Code No.	Qty.	Diagram	Model	Code No.	Qty.	Diagram
0.4										
0.75	2	2	F6045GB	FIL001098	1	a	F6045GB	FIL001098	1	a
1.5										
2.2										
3.7										
5.5										
7.5	5.5	5.5								
11	14	14	F6045GB	FIL001098	4	b	F6045GB	FIL001098	4	b
15										
18.5										
22										
30										
37	22	22								
45	30	30								
55	38	38								
75	60	60								
90	80	80								
110	125	125	F11080GB	FIL001097	4	b	F11080GB	FIL001097	4	b
132	150	150								
160	200	200								
185	250	250								
220	100 × 2P	125 × 2P	F200160PB	300-001-041	4	b	F200160PB	300-001-041	4	b
250	125 × 2P	150 × 2P								
315	80 × 4P	80 × 4P								
355										
450	125 × 4P	125 × 4P								
500	150 × 4P	150 × 4P								
560	100 × 8P	100 × 8P								
630	125 × 8P	125 × 8P								

## Fuse and Fuse Holder

Install a fuse to the drive input terminals to prevent damage in case a fault occurs.  
Refer to the instruction manual for information on UL-approved components.

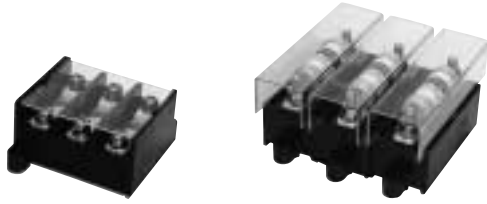

[Fuji Electric FA Components & Systems Co., Ltd]

### Connection Diagram

This example shows a DC power supply (two A1000 drives connected in series).  
For an AC power supply, see the connection diagram on page 28.

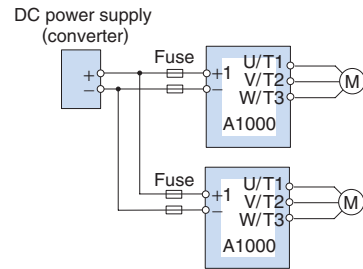

Note: When connecting multiple drives together, make sure that each drive has its own fuse. If any one fuse blows, all fuses should be replaced.

### 200 V Class

Model CIMR-AA2A [XXXXXXXX]	AC Power Supply Input				DC Power Supply Input											
	Fuse		Fuse Holder		Fuse		Fuse Holder									
	Model	Rated Short-circuit Breaking Current (kA)	Qty.	Model	Qty.	Model	Rated Short-circuit Breaking Current (kA)	Qty.	Model	Qty.						
0004	CR2LS-30	100	3	CM-1A	1	CR2LS-30	100	2	CM-1A	1						
0006																
0008																
0010																
0012																
0018																
0021			CR2LS-50	100	3	CM-2A		1	CR2LS-50	100	2	CM-2A	1			
0030																
0040																
0056																
0069																
0081																
0110					CR2L-125	100		3	*		2	*	200	3	*	2
0138																
0169																
0211																
0250																
0312																
0360	CR2L-150	200					3	*	2		*	200		3	*	2
0415																
0415																
0415																
0415																
0415																
0415			CR2L-175	200			3	*	2	*	200			3	*	2
0415																
0415																
0415																
0415																
0415																
0415					CR2L-200	200	3	*	2	*			200	3	*	2
0415																
0415																
0415																
0415																
0415																
0415	CR2L-225	200					3	*	2	*		200		3	*	2
0415																
0415																
0415																
0415																
0415																
0415			CR2L-250	200			3	*	2	*	200			3	*	2
0415																
0415																
0415																
0415																
0415																
0415					CR2L-260	200	3	*	2	*			200	3	*	2
0415																
0415																
0415																
0415																
0415																
0415	CR2L-300	200					3	*	2	*		200		3	*	2
0415																
0415																
0415																
0415																
0415																
0415			CR2L-350	200			3	*	2	*	200			3	*	2
0415																
0415																
0415																
0415																
0415																
0415					CR2L-400	200	3	*	2	*			200	3	*	2
0415																
0415																
0415																
0415																
0415																
0415	CR2L-450	200					3	*	2	*		200		3	*	2
0415																
0415																
0415																
0415																
0415																
0415			CR2L-600	200			3	*	2	*	200			3	*	2
0415																
0415																
0415																
0415																
0415																
0415					CS5F-800	200	3	*	2	*			200	3	*	2
0415																
0415																
0415																
0415																
0415																
0415	CS5F-1200	200					3	*	2	*		200		3	*	2
0415																
0415																
0415																
0415																
0415																

\* Manufacturer does not recommend a specific fuse holder for this fuse.  
Contact the manufacturer for information on fuse dimensions.

### 400 V Class

Model CIMR-AA4A [XXXXXXXX]	AC Power Supply Input				DC Power Supply Input											
	Fuse		Fuse Holder		Fuse		Fuse Holder									
	Model	Rated Short-circuit Breaking Current (kA)	Qty.	Model	Qty.	Model	Rated Short-circuit Breaking Current (kA)	Qty.	Model	Qty.						
0002	CR6L-20	100	3	CMS-4	3	CR6L-20	100	2	CMS-4	2						
0004																
0005																
0007																
0009																
0011																
0018			CR6L-30	100	3	CMS-5		3	CR6L-30	100	2	CMS-5	2			
0023																
0031																
0038																
0044																
0058																
0072					CR6L-50	100		3	*		2	*	200	3	*	2
0088																
0103																
0139																
0165																
0208																
0250	CR6L-75	100					3	*	2		*	200		3	*	2
0296																
0362																
0414																
0515																
0675																
0930			CR6L-100	100			3	*	2	*	200			3	*	2
1200																
0250																
0296																
0362																
0414																
0515					CR6L-150	100	3	*	2	*			200	3	*	2
0675																
0930																
1200																
0250																
0296																
0362	CR6L-200	100					3	*	2	*		200		3	*	2
0414																
0515																
0675																
0930																
1200																
0250			CR6L-250	100			3	*	2	*	200			3	*	2
0296																
0362																
0414																
0515																
0675																
0930					CR6L-300	100	3	*	2	*			200	3	*	2
1200																
0250																
0296																
0362																
0414																
0515	CR6L-350	100					3	*	2	*		200		3	*	2
0675																
0930																
1200																
0250																
0296																
0362			CR6L-400	100			3	*	2	*	200			3	*	2
0414																
0515																
0675																
0930																
1200																
0250					CR6L-450	100	3	*	2	*			200	3	*	2
0296																
0362																
0414																
0515																
0675																
0930	CR6L-600	100					3	*	2	*		200		3	*	2
1200																
0250																
0296																
0362																
0414																
0515			CS5F-600	200			3	*	2	*	200			3	*	2
0675																
0930																
1200																
0250																
0296																
0362					CS5F-800	200	3	*	2	*			200	3	*	2
0414																
0515																
0675																
0930																
1200																
0250	CS5F-1000	200					3	*	2	*		200		3	*	2
0296																
0362																
0414																
0515																
0675																
0930			CS5F-1200	200			3	*	2	*	200			3	*	2
1200																
0250																
0296																
0362																
0414																
0515					CS5F-1500	200	3	*	2	*			200	3	*	2
0675																
0930																
1200																
0250																
0296																
0362	CS5F-1500	200					3	*	2	*		200		3	*	2
0414																
0515																
0675																
0930																
1200																

Note: Always install input fuses for models CIMR-AA4A0930 and CIMR-AA4A1200.

## Capacitor-Type Noise Filter

Capacitor-type noise filter exclusively designed for drive input.

The noise filter can be used in combination with a zero-phase reactor. For both 200 V and 400 V classes.

Note: The capacitor-type noise filter can be used for drive input only. Do not connect the noise filter to the output terminals.



[Okaya Electric Industries Co., Ltd.]

### Connection Diagram

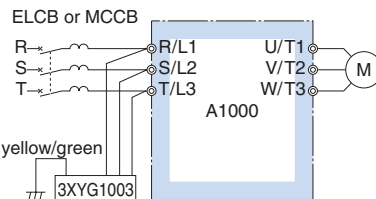

### Specifications

Model	Code No.
3XYG 1003	C002889

Rated Voltage	Capacitance (3 devices each)	Operating Temperature (°C)
440 V	X (Δ connection) : 0.1 μF ± 20 % Y (A connection) : 0.003 μF ± 20 %	- 40 to +85

Note: For use with 460 V and 480 V units, contact Yaskawa directly.

### Dimensions (mm)

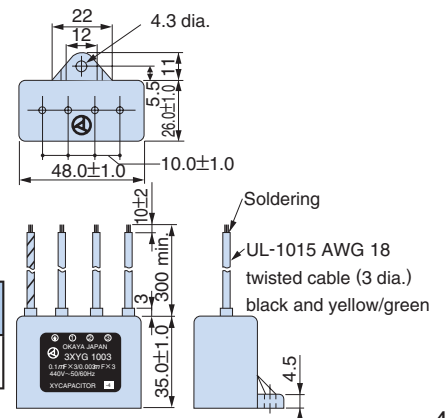

### Input Noise Filter

Base device selection on motor capacity.

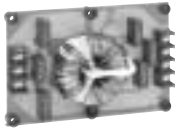

Noise Filter without Case



Noise Filter with Case



**Noise Filter**  
[Schaffner EMC K.K.]  
Note: Refer to the instruction manual for information on the CE mark and compliance with the EMC directive.

### Connection Diagram

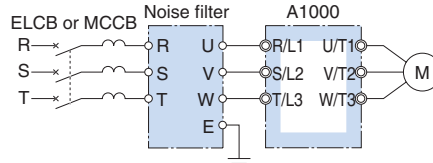

Note: Do not connect the input noise filter to the drive output terminals (U, V, W). Connect in parallel when using two filters.

Connecting Noise Filters in Parallel to the Input or Output Side (examples shows two filters in parallel)

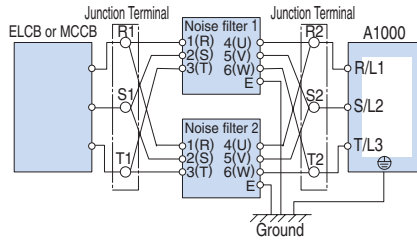

Note: When wiring contactors in parallel, make sure wiring lengths are the same to keep current flow even to the relay terminals. Noise filters and grounding wire should be as heavy and as short as possible.

### 200 V Class

Motor Capacity (kW)	Noise Filter without Case				Noise Filter with Case				Noise Filter by Schaffner EMC K.K.			
	Model	Code No.	Qty.	Rated Current (A)	Model	Code No.	Qty.	Rated Current (A)	Model	Code No.	Qty.	Rated Current (A)
0.4												
0.75	LNFD-2103DY	FIL000132	1	10	LNFD-2103HY	FIL000140	1	10	-	-	-	-
1.5												
2.2	LNFD-2153DY	FIL000133	1	15	LNFD-2153HY	FIL000141	1	15	-	-	-	-
3.7	LNFD-2303DY	FIL000135	1	30	LNFD-2303HY	FIL000143	1	30	-	-	-	-
5.5	LNFD-2203DY	FIL000134	2	40	LNFD-2203HY	FIL000142	2	40	FN258L-42-07	FIL001065	1	42
7.5			2	60			2	60	FN258L-55-07	FIL001066	1	55
11			3	90			3	90	FN258L-75-34	FIL001067	1	75
15	LNFD-2303DY	FIL000135	3	90	LNFD-2303HY	FIL000143	3	90	FN258L-100-35	FIL001068	1	100
18.5			4	120			4	120	FN258L-130-35	FIL001069	1	130
22									FN258L-130-35	FIL001069	1	130
30												
37												
45									FN258L-180-07	FIL001070	1	180
55	-	-	-	-	-	-	-	-	FN359P-250-99	FIL001071	1	250
75									FN359P-400-99	FIL001073	1	400
90									FN359P-500-99	FIL001074	1	500
110									FN359P-600-99	FIL001075	1	600

### 400 V Class

Motor Capacity (kW)	Noise Filter without Case				Noise Filter with Case				Noise Filter by Schaffner EMC K.K.			
	Model	Code No.	Qty.	Rated Current (A)	Model	Code No.	Qty.	Rated Current (A)	Model	Code No.	Qty.	Rated Current (A)
0.4												
0.75	LNFD-4053DY	FIL000144	1	5	LNFD-4053HY	FIL000149	1	5				
1.5												
2.2	LNFD-4103DY	FIL000145	1	10	LNFD-4103HY	FIL000150	1	10	-	-	-	-
3.7	LNFD-4153DY	FIL000146	1	15	LNFD-4153HY	FIL000151	1	15				
5.5	LNFD-4203DY	FIL000147	1	20	LNFD-4203HY	FIL000152	1	20				
7.5	LNFD-4303DY	FIL000148	1	30	LNFD-4303HY	FIL000153	1	30				
11	LNFD-4203DY	FIL000147	2	40	LNFD-4203HY	FIL000152	2	40	FN258L-42-07	FIL001065	1	42
15			2	60			2	60	FN258L-55-07	FIL001066	1	55
18.5			3	90			3	90	FN258L-75-34	FIL001067	1	75
22	LNFD-4303DY	FIL000148	3	90	LNFD-4303HY	FIL000153	3	90	FN258L-100-35	FIL001068	1	100
30			4	120			4	120	FN258L-100-35	FIL001068	1	100
37									FN258L-130-35	FIL001069	1	130
45									FN258L-180-07	FIL001070	1	180
55									FN359P-300-99	FIL001072	1	300
75									FN359P-400-99	FIL001073	1	400
90									FN359P-500-99	FIL001074	1	500
110									FN359P-600-99	FIL001075	1	600
132												
160												
185												
220												
250												
315												
355									FN359P-900-99	FIL001076	1	900
450												
500									FN359P-600-99	FIL001075	2	1200
560												
630									FN359P-900-99	FIL001076	2	1800

Without Case

Dimensions (mm)

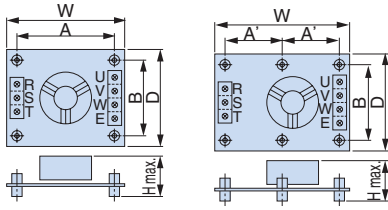
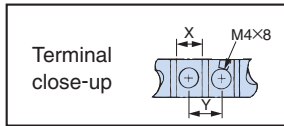

Figure 1

Figure 2



Model LNFD	Code No.	Figure	Dimensions (mm)								Terminal (mm)		Mounting Screw	Weight (kg)
			W	D	H	A	A'	B	M	X	Y			
2103DY	FIL000132	1	120	80	55	108	—	68	20	9	11	M4 × 4,20 mm	0.2	
2153DY	FIL000133	1				68								
2203DY	FIL000134	1	170	90	70	158	78	78	20	9	11	M4 × 4,20 mm	0.4	
2303DY	FIL000135	2				—	79							98
4053DY	FIL000144	2	170	130	75	—	79	118	30	9	11	M4 × 6,30 mm	0.3	
4103DY	FIL000145	2												95
4153DY	FIL000146	2	200	145	100	—	94	133	30	9	11	M4 × 4,30 mm	0.5	
4203DY	FIL000147	2												10
4303DY	FIL000148	2	10	13	0.6									

With Case

Dimensions (mm)

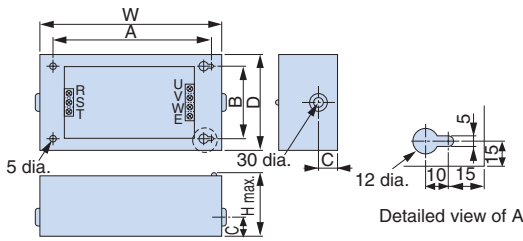

The figure shows an example of three-phase input.

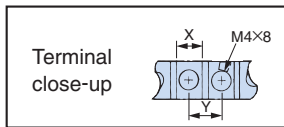

Model LNFD	Code No.	Dimensions (mm)							Terminal (mm)		Weight (kg)
		W	D	H	A	B	C	X	Y		
2103HY	FIL000140	185	95	85	155	65	33	9	11	0.9	
2153HY	FIL000141										
2203HY	FIL000142	240	125	100	210	95	33	9	11	1.5	
2303HY	FIL000143										10
4053HY	FIL000149	235	140	120	205	110	43	9	11	1.6	
4103HY	FIL000150										
4153HY	FIL000151	270	155	125	240	125	43	9	11	1.7	
4203HY	FIL000152										10
4303HY	FIL000153	10	13	2.2							

Manufactured by Schaffner EMC K.K.

Dimensions (mm)

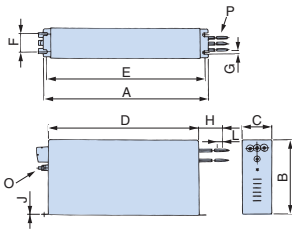

Figure 1

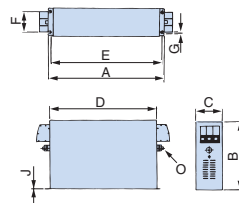

Figure 2

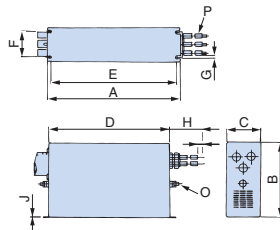

Figure 3

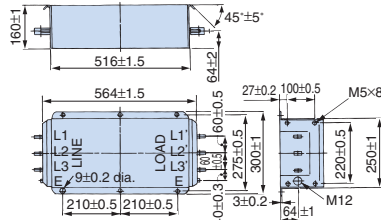

Figure 4

Model	Weight (kg)
FN359P-250-99	16
FN359P-300-99	16
FN359P-400-99	18.5
FN359P-500-99	19.5
FN359P-600-99	20.5
FN359P-900-99	33

Model	Figure	Dimensions (mm)											Wire Gauge	Weight (kg)
		A	B	C	D	E	F	G	H	J	L	O		
FN258L-42-07	1	329	185 ± 1	70	300	314	45	6.5	500	1.5	12	M6	AWG8	2.8
FN258L-55-07			220	80			—				—		AWG6	
FN258L-75-34			—	—			—				—		—	
FN258L-100-35	2	379 ± 1.5	220	90 ± 0.8	350 ± 1.2	364	65	6.5	—	1.5	—	M10	—	5.5
FN258L-130-35	2	439 ± 1.5	240	110 ± 0.8	400 ± 1.2	414	80			3			—	7.5
FN-258L-180-07	3	438 ± 1.5	240	110 ± 0.8	400 ± 1.2	413	80	500	4	15	50 mm <sup>2</sup>	11		
FN359P- [ ]	4	Described in Figure 4											Shown in the above table.	

Note: For CE Marking (EMC Directive) compliant models, contact us for inquiry.

### Output Noise Filter

Base device selection on motor capacity.



[NEC Tokin Corporation]

Connection Diagram

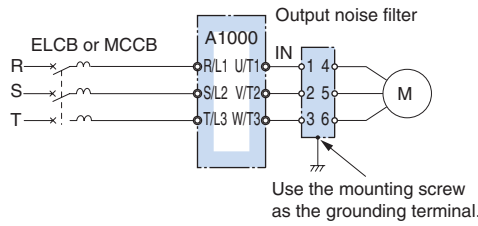

Dimensions (mm)

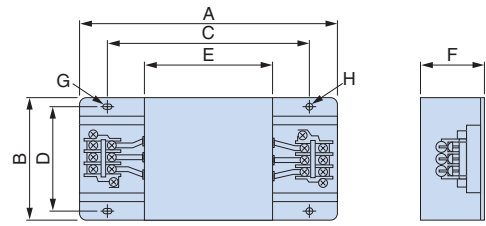

### 200 V Class

Motor Capacity (kW)	Model	Code No.	Qty.*1	Rated Current (A)	Dimensions (mm)								Terminal	Weight*2 (kg)
					A	B	C	D	E	F	G	H		
0.4	LF-310KA	FIL000068	1	10	140	100	100	90	70	45	7×φ4.5	φ4.5	TE-K5.5 M4	0.5
0.75														
1.5														
2.2	LF-320KA	FIL000069	1	20	140	100	100	90	70	45	7×φ4.5	φ4.5	TE-K5.5 M4	0.6
3.7														
5.5	LF-350KA	FIL000070	1	50	260	180	180	160	120	65	7×φ4.5	φ4.5	TE-K22 M6	2.0
7.5														
11														
15														
18.5	LF-350KA*3	FIL000070	3	150	260	180	180	160	120	65	7×φ4.5	φ4.5	TE-K22 M6	2.0
22		FIL000076	1	110	540	340	480	300	340	240	9×φ6.5	φ6.5	TE-K60 M8	19.5
30	LF-350KA*3	FIL000070	3	150	260	180	180	160	120	65	7×φ4.5	φ4.5	TE-K22 M6	2.0
37	LF-3110KB	FIL000076	2	220	540	340	480	300	340	240	9×φ6.5	φ6.5	TE-K60 M8	19.5
45														
55														
75														
90														
110	LF-3110KB	FIL000076	3	330	540	340	480	300	340	240	9×φ6.5	φ6.5	TE-K60 M8	19.5
90	4	440												
110	5	550												

\*1: Connect in parallel when using more than one filter.

\*2: Weight of one filter.

\*3: Either noise filter model can be used.

### 400 V Class

Motor Capacity (kW)	Model	Code No.	Qty.*1	Rated Current (A)	Dimensions (mm)								Terminal	Weight*2 (kg)
					A	B	C	D	E	F	G	H		
0.4	LF-310KB	FIL000071	1	10	140	100	100	90	70	45	7×φ4.5	φ4.5	TE-K5.5 M4	0.5
0.75														
1.5														
2.2	LF-320KB	FIL000072	1	20	140	100	100	90	70	45	7×φ4.5	φ4.5	TE-K5.5 M4	0.6
3.7														
5.5	LF-335KB	FIL000073	1	35	140	100	100	90	70	45	7×φ4.5	φ4.5	TE-K5.5 M4	0.8
7.5														
11														
15	LF-345KB	FIL000074	1	45	260	180	180	160	120	65	7×φ4.5	φ4.5	TE-K22 M6	2.0
18.5														
22	LF-375KB	FIL000075	1	75	540	320	480	300	340	240	9×φ6.5	φ6.5	TE-K22 M6	12.0
30	LF-3110KB	FIL000076	1	110	540	340	480	300	340	240	9×φ6.5	φ6.5	TE-K60 M8	19.5
37														
45	LF-3110KB	FIL000076	2	220	540	340	480	300	340	240	9×φ6.5	φ6.5	TE-K60 M8	12.0
55														
75														
90														
110														
132														
160														
185														
220														
250														
315														
355														
450														
500														
560														
630														

\*1: Connect in parallel when using more than one filter.

\*2: Weight of one filter.

## 24 V Power Supply

The 24 V Power Supply Option maintains drive control circuit power in the event of a main power outage. The control circuit keeps the network communications and I/O data operational in the event of a power outage. It supplies external power to the control circuit only.

Note: Even if a back-up power supply is used for the control circuit, the main circuit must still have power in order to change parameter settings.

The installed option adds 50 mm to the total depth of the drive.  
Installed internally for models 185 kW (CIMR-AA4A0414) and above.

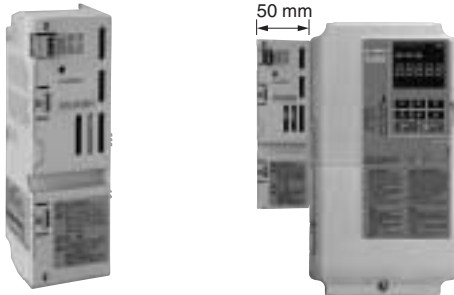

Weight: 0.2 kg

Model	Code No.
200 V Class: PS-A10L	PS-A10L
400 V Class: PS-A10H	PS-A10H

### Connection Diagram

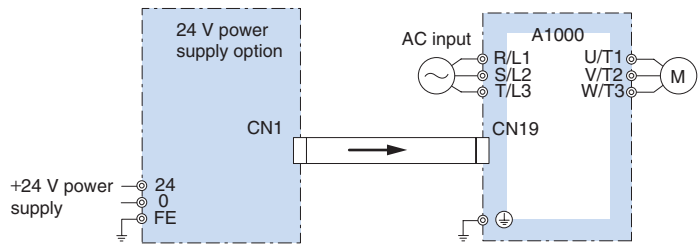

## Momentary Power Loss Recovery Unit

### Connection Diagram



Weight: 2 kg

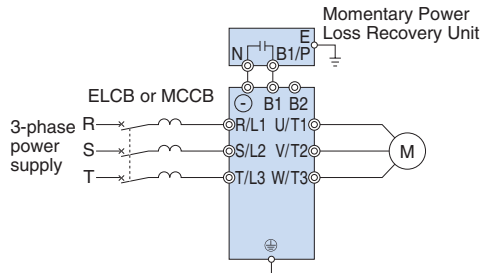

### Dimensions (mm)

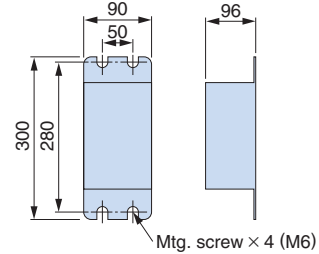

Model	Code No.
200 V Class: P0010	P0010
400 V Class: P0020	P0020

Note: Functions as a back-up power supply for drives up to 11 kW. Allows the drive to ride through a power loss up to 2 s long. The drive alone can continue running through a power loss lasting 0.1 s to 1.0 s. Results may vary with drive capacity.

### Braking Unit, Braking Resistor, Braking Resistor Unit

Braking units come standard with 200 V and 400 V class drives 0.4 to 30 kW. If the application requires a braking resistor or braking unit, choose from built-in and stand-alone types in accordance with motor capacity.



Stand-alone

Braking Unit  
[CDBR series]



Built-in

Braking Resistor  
[ERF-150WJ series]



Built-in

Braking Resistor with Fuse  
[CF120-B579 series]



Stand-alone

Braking Resistor Unit  
[LKEB series]



Stand-alone

### 200 V Class

Max. Applicable Motor (kW)	ND/HD	A1000 Model CIMR-AA2A	Braking Unit		Braking Resistor (Duty Factor: 3% ED, 10 s max.)*1								Braking Resistor Unit (Duty Factor: 10% ED, 10 s max.)*1					Min.*2 Connectable Resistance (Ω)		
			Model CDBR-	Qty.	No Fuse				With Fuse				Model LKEB-	Resistor Specifications (per unit)		Qty.	Diagram		Braking Torque*3 (%)	
					Model ERF-150WJ	Resistance (Ω)	Qty.	Diagram	Braking Torque*3 (%)	Model CF120-B579	Resistance (Ω)	Qty.		Diagram	Braking Torque*3 (%)					Resistance (Ω)
0.4	HD	0004			201	200	1	A	220	B	200	1	A	220	20P7	70 W 200 Ω	1	B	220	48
0.75	ND	0004			201	200	1	A	125	B	200	1	A	125	20P7	70 W 200 Ω	1	B	125	48
	HD	0006																		
1.1	ND	0006			201	200	1	A	85	B	200	1	A	85	20P7	70 W 200 Ω	1	B	85	48
	HD	0008			101	100			150	C	100			1	150	21P5			260 W 100 Ω	
1.5	ND	0008			101	100	1	A	125	C	100	1	A	125	21P5	260 W 100 Ω	1	B	125	48
	HD	0010																		
2.2	ND	0010			700	70	1	A	120	D	70	1	A	120	22P2	260 W 70 Ω	1	B	120	48
	HD	0012																		16
3	ND	0012			620	62	1	A	100	E	62	1	A	100	22P2	390 W 40 Ω	1	B	150	16
	HD	0018																		
3.7	ND	0018			620	62	1	A	80	E	62	1	A	80	23P7	390 W 40 Ω	1	B	125	16
	HD	0021																		
5.5	ND	0021			620	62	2	A	110	E	62	2	A	110	25P5	520 W 30 Ω	1	B	115	16
	HD	0030																		
7.5	ND	0030													27P5	780 W 20 Ω	1	B	125	16
	HD	0040																		9.6
11	ND	0040													2011	2400 W 13.6 Ω	1	B	125	9.6
	HD	0056																		
15	ND	0056													2015	3000 W 10 Ω	1	B	125	9.6
	HD	0069																		
18.5	ND	0069													2015	3000 W 10 Ω	1	B	100	9.6
	HD	0081																		
22	ND	0081												2015	3000 W 10 Ω	1	B	85	9.6	
	HD	0110												2022	4800 W 6.8 Ω			125	6.4	
30	ND	0110												2022	4800 W 6.8 Ω	1	B	90	6.4	
	HD	0138																		
37	ND	0138												2022	4800 W 6.8 Ω	1	B	70	6.4	
	HD	0169	2015B	2										2015	3000 W 10 Ω	2	D	100	9.6	
45	ND	0169	2015B	2										2015	3000 W 10 Ω	2	D	80	9.6	
	HD	0211	2022B	2										2022	4800 W 6.8 Ω			120	6.4	
55	ND	0211												2022	4800 W 6.8 Ω	2	D	100	6.4	
	HD	0250	2022B	2																
75	ND	0250												2022	4800 W 6.8 Ω	3	E	110	1.6	
	HD	0312	2110B	1																
90	ND	0312												2022	4800 W 6.8 Ω	4	E	120	1.6	
	HD	0360	2110B	1																
110	ND	0360																		
	HD	0415	2110B	1										2018	4800 W 8 Ω	5	E	100	1.6	

\*1 : Refers to a motor coasting to stop with a constant torque load. Constant output and regenerative braking will reduce the duty factor.  
 \*2 : Assumes the use of a single braking unit. The braking unit should have a resistance higher than the minimum connectable resistance value and be able to generate enough braking torque to stop the motor.  
 \*3 : Applications with a relatively large amount of regenerative power (elevators, hoists, etc.) may require more braking power than is possible with only the standard braking unit and braking resistor. Contact Yaskawa for information if braking torque exceeds the value shown.  
 Note: 1. Braking resistor (ERF-150WJ and CF120-B579) requires a separate attachment for installation. See attachment for braking resistor unit on page 51.  
 2. If the built-in fuse on a braking resistor blows, then the entire braking resistor should be replaced.  
 3. See the connection diagram on page 50.



## 400 V Class

Max. Applicable Motor (kW)	ND/HD	A1000 Model CIMR-AA4A	Braking Unit		Braking Resistor (Duty Factor: 3% ED, 10 s max.)*1								Braking Resistor Unit (Duty Factor: 10% ED, 10 s max.)*1					Min.*2 Connectable Resistance (Ω)		
			Model CDBR-	Qty.	No Fuse				With Fuse				Model LKEB-	Resistor Specifications (per unit)	Qty.	Diagram	Braking Torque*3 (%)			
					Model ERF-150WJ	Resistance (Ω)	Qty.	Diagram	Braking Torque*3 (%)	Model CF120-B579	Resistance (Ω)	Qty.							Diagram	Braking Torque*3 (%)
0.4	HD	0002			751	750	1	A	230	F	750	1	A	230	40P7	70 W 750 Ω	1	B	230	96
0.75	ND	0002			751	750	1	A	130	F	750	1	A	130	40P7	70 W 750 Ω	1	B	130	96
	HD	0004																		
1.5	ND	0004			401	400	1	A	125	G	400	1	A	125	41P5	260 W 400 Ω	1	B	125	96
	HD	0005																		64
2.2	ND	0005			301	300	1	A	115	H	300	1	A	115	42P2	260 W 250 Ω	1	B	135	64
	HD	0007																		
3	ND	0007			201	200	1	A	125	J	250	1	A	100	42P2	260 W 250 Ω	1	B	100	64
	HD	0009												43P7	390 W 150 Ω	150			32	
3.7	ND	0009			201	200	1	A	105	J	250	1	A	83	43P7	390W 150 Ω	1	B	135	32
	HD	0011																		
5.5	ND	0011			201	200	2	A	135	J	250	2	A	105	45P5	520 W 100 Ω	1	B	135	32
	HD	0018																		
7.5	ND	0018												47P5	780 W 75 Ω	1	B	130	32	
	HD	0023																		
11	ND	0023												4011	1040 W 50 Ω	1	B	135	32	
	HD	0031																		20
15	ND	0031												4015	1560 W 40 Ω	1	B	125	20	
	HD	0038																		
18.5	ND	0038												4018	4800 W 32 Ω	1	B	125	20	
	HD	0044																		19.2
22	ND	0044												4022	4800 W 27.2 Ω	1	B	125	19.2	
	HD	0058																		
30	ND	0058												4030	6000 W 20 Ω	1	B	125	19.2	
	HD	0072																		
37	ND	0072												4030	6000 W 20 Ω	1	B	100	19.2	
	HD	0088	4045B	1										4037	9600 W 16 Ω		C	125	12.8	
45	ND	0088												4045	9600 W 13.6 Ω	1	C	125	12.8	
	HD	0103	4045B	1																
55	ND	0103	4045B	1										4045	9600 W 13.6 Ω	1	C	100	12.8	
	HD	0139	4030B	2										4030	6000 W 20 Ω	2	D	135	19.2	
75	ND	0139	4030B	2										4030	6000 W 20 Ω	2	D	100	19.2	
	HD	0165	4045B											4045	9600W 13.6 Ω			145	12.8	
90	ND	0165	4045B	2										4045	9600W 13.6 Ω	2	D	100	12.8	
	HD	0208																		
110	ND	0208												4030	6000 W 20 Ω	3	E	100	3.2	
	HD	0250	4220B	1																
132	ND	0250												4045	9600W 13.6 Ω	4	E	140	3.2	
	HD	0296	4220B	1																
160	ND	0296												4045	9600W 13.6 Ω	4	E	140	3.2	
	HD	0362	4220B	1																
185	ND	0362												4045	9600W 13.6 Ω	4	E	120	3.2	
	HD	0414	4220B	1																
220	ND	0414												4037	9600 W 16 Ω	5	E	110	3.2	
	HD	0515	4220B	1																
250	ND	0515	4220B	1										4037	9600 W 16 Ω	5	E	90	3.2	
315	HD	0675	4220B	2										4045	9600 W 13.6 Ω	6	E	100	3.2	
355	ND	0675	4220B	2										4045	9600 W 13.6 Ω	8	E	120	3.2	
450	HD	0930	4220B	2										4037	9600 W 16 Ω	10	E	100	3.2	
500	ND	0930	4220B	2										4037	9600 W 16 Ω	10	E	90	3.2	
560	HD	1200	4220B	3										4037	9600 W 16 Ω	15	E	120	3.2	
630	ND	1200	4220B	3										4037	9600 W 16 Ω	15	E	100	3.2	

\*1 : Refers to a motor coasting to stop with a constant torque load. Constant output and regenerative braking will reduce the duty factor.

\*2 : Assumes the use of a single braking unit. The braking unit should have a resistance higher than the minimum connectable resistance value and be able to generate enough braking torque to stop the motor.

\*3 : Applications with a relatively large amount of regenerative power (elevators, hoists, etc.) may require more braking power than is possible with only the standard braking unit and braking resistor. Contact Yaskawa for information if braking torque exceeds the value shown.

Note: 1. Braking resistor (ERF-150WJ and CF120-B579) requires a separate attachment for installation. See attachment for braking resistor unit on page 51.

2. If the built-in fuse on a braking resistor blows, then the entire braking resistor should be replaced.

3. See the connection diagram on page 50.

### Connection Diagram

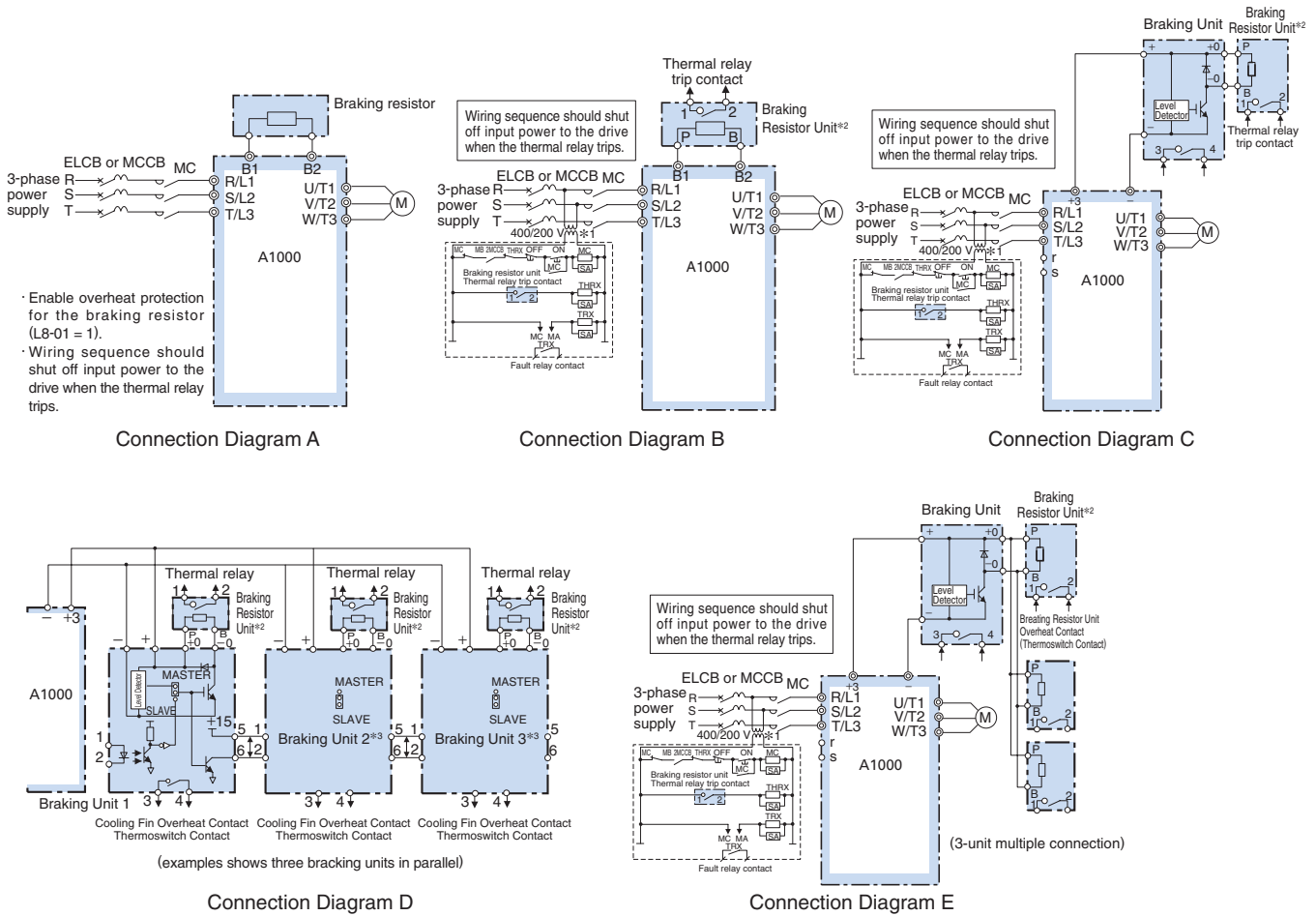

- \*1: 200 V class drives do not require a control circuit transformer.
  - \*2: Disable Stall Prevention during deceleration by setting L3-04 to 0 or 3 when using a Braking Resistor Unit.  
The motor may not stop within the deceleration time if this setting is not changed.
  - \*3: When using more than one braking unit connected in parallel, set one of the braking units to be the master, and the others to be slaves.
- Note: When connecting a separately-installed type braking resistor unit (model CDBR) to drives with a built-in braking transistor (200 V/400 V 30 kW or less), connect the B1 terminal of the drive to the positive terminal of the braking resistor unit and connect the negative terminal of the drive to the negative terminal of the braking resistor unit. The B2 terminal is not used in this case.

### Dimensions (mm) Braking Unit

Model: CDBR-2015B, -2022B, -4030B, -4045B

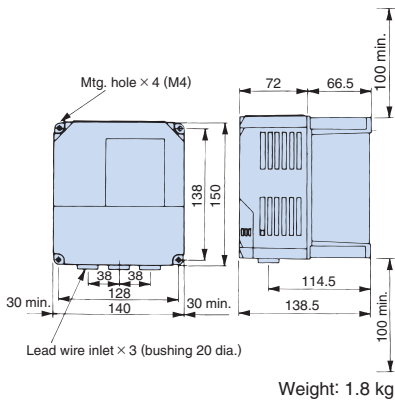

Model: CDBR-2110B

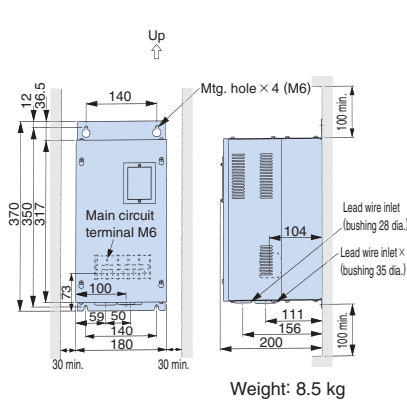

Model: CDBR-4220B

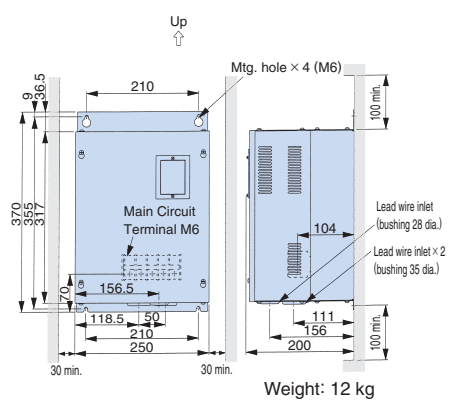

Model	Heat Loss (W)
CDBR-2015B	32
2022B	38
2110B	64
4030B	54
4045B	59
4220B	71

## Braking Resistor

A separate attachment is need. Contact Yaskawa for details.  
The following attachment can be used to install to the drive.

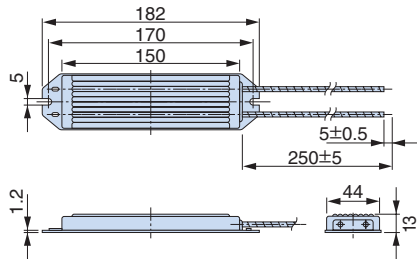

ERF-150WJ series

Weight: 0.2 kg  
(All ERF-150WJ series models)

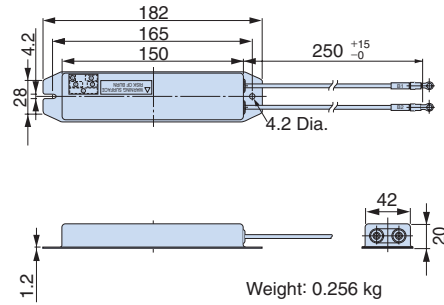

CF120-B579 series

Weight: 0.256 kg  
(All CF120-B579 series models)

## Braking Resistor Unit (stand-alone)

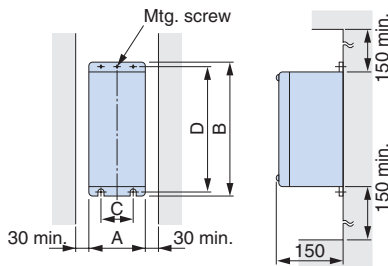

Figure 1

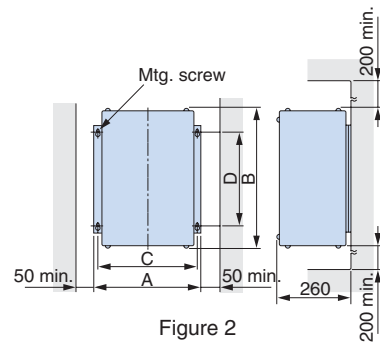
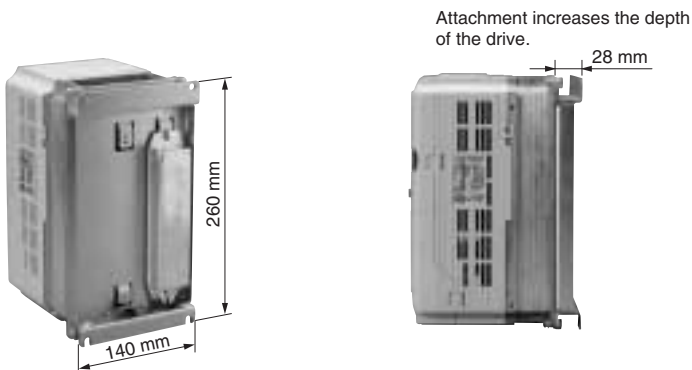

Figure 2

Applicable Voltage Class	Braking Resistor Unit Model LKEB-□□□□□□	Figure	Dimensions (mm)					Weight (kg)	Allowable Average Power Consumption (W)	
			A	B	C	D	MTG Screw			
200 V Class	20P7	1	105	275	50	260	M5×3	3.0	30	
	21P5	1	130	350	75	335	M5×4	4.5	60	
	22P2							4.5	89	
	23P7							5.0	150	
	25P5	1	250	350	200	335	M6×4	7.5	220	
	27P5							8.5	300	
	2011	2	543	426	340	M8×4	266	246	10	440
	2015						356	336	15	600
	2018						446	426	19	740
2022	446						426	19	880	











Applicable Voltage Class	Braking Resistor Unit Model LKEB-□□□□□□	Figure	Dimensions (mm)					Weight (kg)	Allowable Average Power Consumption (W)			
			A	B	C	D	MTG Screw					
400 V Class	40P7	1	105	275	50	260	M5×3	3.0	30			
	41P5	1	130	350	75	335	M5×4	4.5	60			
	42P2							4.5	89			
	43P7							5.0	150			
	45P5	1	250	350	200	335	M6×4	7.5	220			
	47P5							8.5	300			
	4011	2	543	426	340	M8×4	350	412	330	325	16	440
	4015						18	600				
	4018						19	740				
	4022	2	956	426	740	M8×4	446	543	426	340	19	880
	4030						356	336	25	1200		
	4037						446	956	426	33	1500	
	4045						446	426	33	1800		

## Attachment for Braking Resistor







Model	Code No.
EZZ020805A	100-048-123

### ● VS System Module (Power Supply Capacity 6 VA or less)

Name (Model)	Exterior	Function
Soft Starter A (JGSM-01) Soft Starter B (JGSM-02)		Provides smooth changes in speed during start, stop, and when sudden changes in the speed reference would otherwise impact the load. Independent accel/decel settings, an output signal during speed changes, and fast stopping features are included. Capable of detecting zero speed and motor direction. Acceleration and deceleration time setting ranges: Soft Starter A: 1.5 to 30 s Soft Starter B: 5 to 90 s
Ratio Setter A (JGSM-03)		Converts the current signal 4 to 20 mA of master setter JVOP-03*1 to a voltage signal. Sets five types of ratios and biases.
Ratio Setter B (JGSM-04)		Converts the frequency signal 0 to 2 kHz of master setter JVOP-04*1 to a voltage signal. Sets five types of ratios and biases.
Ratio Setter C (JGSM-17)		Converts a 200 Vac signal, a 30 Vac tachgenerator signal, or a 10 Vdc signal to DC for use as the speed reference. Allows the user to set up to five ratios and biases.
Follower Ratio Setter (JGSM-05)		Converts a frequency signal from a tachgenerator for voltage input. Allows the user to set up to five ratios and biases.
Position Controller (JGSM-06)		Converts a self-synchronizing signal from YVGC-500W*1, then converts that signal to DC voltage proportional to the rotational angle. Equipped with a signal mixing function to minimize deviation from the reference signal.
PID Controller (JGSM-07)		Independently sets ratio gain, integral, and differential time for the simple process control. Integral reset, stepless operation, and wind-up functions are available.
Preamplifier (JGSM-09-□□)*2		Amplifies both the power of DC input signal and output of snap-in function modules JZSP-11 to 16*1.
UP/DOWN Setter (JGSM-10B)		Executes "UP" or "DOWN" command from remote control type VS operator model JVOP-10*1 by lowering or raising reference voltage.
Operational Amplifier (JGSM-12-□□)*3		Required operational circuits are provided through a range of operational impedances.
Signal Selector A (JGSM-13)		Consists of power supply circuit and two relay circuits. Used as a selector circuit of control signals.



Name (Model)	Appearance	Function
Signal Selector B (JGSM-14)		Contains three relay circuits to switch between control signals. Must be using in combination with JGSM-13, which supplies power.
Comparator (JGSM-15-□□)*2		Detects signal levels for DC voltage, current, AC tachogenerator, or frequency reference and compares them with two preset levels. The snap-in module*1 is used to drive relays and output contact signals.
V/I Converter (JGSM-16-□□)*2		Converts DC voltage into a 4 to 20 mA current signal for use with other monitoring devices. A snap-in module*1 can also be added to monitor frequency or provide feedback for a tachogenerator.
D/A Converter (JGSM-18) (JGSM-19)		Converts BCD 3-digit or 12-bit binary digital signals to analog signals of -10 to +10 V with high accuracy. Model JGSM-18: For BCD 3-digit input signals Model JGSM-19: For 12-bit binary signals
Static Potentiometer (JGSM-21 D/A Converter) (JGSM-22 Controller)		Static potentiometer can be used in combination with remote setting device JGSM-10B for the following applications: · Maintain reference values despite power loss · Set deceleration times externally · Operate as a soft-starter for an analog signal JGSM-21 and JGSM-22 must be used in combination with one another.

\*1: Offered as a standard Yaskawa product.

\*2: □□ shows model number of VS snap-in function modules. Refer to the VS Snap-in Module list for more information.

\*3: □□ indicates impedance class.

Note: Both 200 V/220 V at 50 Hz/60 Hz are available as standard models. Use a transformer for other power supplies with a capacity of 6 VA or less.

### VS System Module Dimensions (mm)

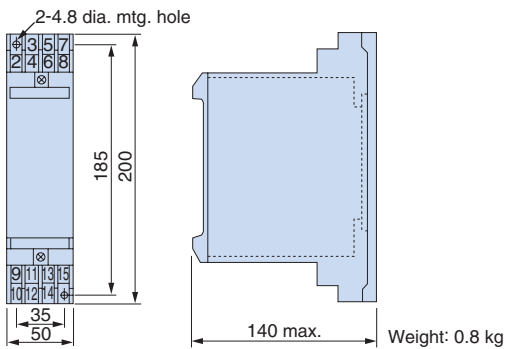

### VS Snap-in Module List

Application	Name	Model
Short-circuit of mounting connector of VS snap-in module	Short-circuit PC board	JZSP-00
Buffer accel/decel operation	Soft starter	JZSP-12
Operation with a process controller or VS operator JVOP-03	I/V converter	JZSP-13
Control using digital operator JVOP-04	f/V converter	JZSP-14
Sequence operation with main unit	Tachogenerator follower	JZSP-15
Amplify or reduce signal	Signal mixer	JZSP-16□□
		JZSP-16-01
		JZSP-16-02
		JZSP-16-03

### LCD Operator

For easier operation when using the optional LCD operator. Includes a copy function for saving drive settings.

Model	Code No.
JVOP-180	100-041-022

Dimensions (mm)

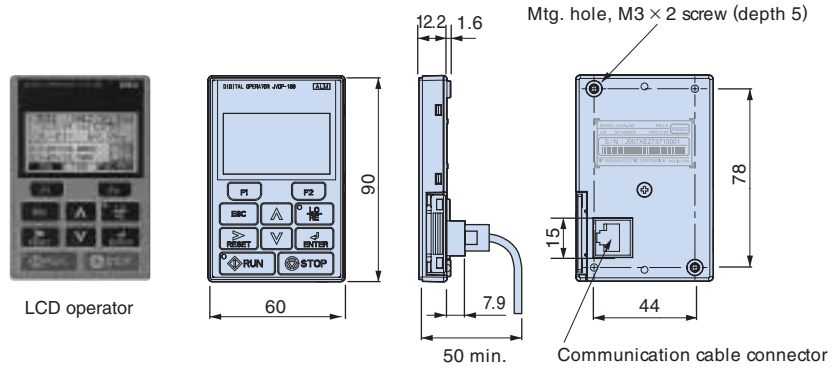

### Operator Extension Cable

Enables remote operation

Model	Code No.
WV001 (1 m)	WV001
WV003 (3 m)	WV003

Note: Never use this cable for connecting the drive to a PC. Doing so may damage the PC.

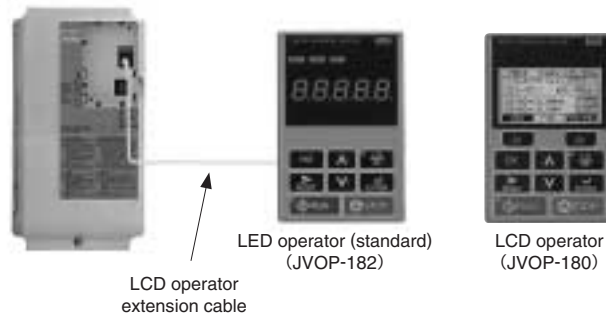

### Operator Mounting Bracket

This bracket is required to mount the LED or LCD operator outside an enclosure panel.

Item	Model	Code No.	Installation	Notes
<p>Installation Support Set A</p>	EZZ020642A	100-039-992	<p>M4×10 truss head screw M3×6 pan head screw</p> <p>13.9 50 min.</p>	For use with holes through the panel
<p>Installation Support Set B</p>	EZZ020642B	100-039-993	<p>M4 nut M3×6 pan head screw</p> <p>13.9 50 min.</p>	<p>For use with panel mounted threaded studs</p> <p>Note: If weld studs are on the back of the panel, use the Installation Support Set B.</p>



## ● USB Copy Unit (Model: JVOP-181)

Copy parameter settings in a single step, then transfer those settings to another drive. Connects to the RJ-45 port on the drive and to the USB port of a PC.

### Connection

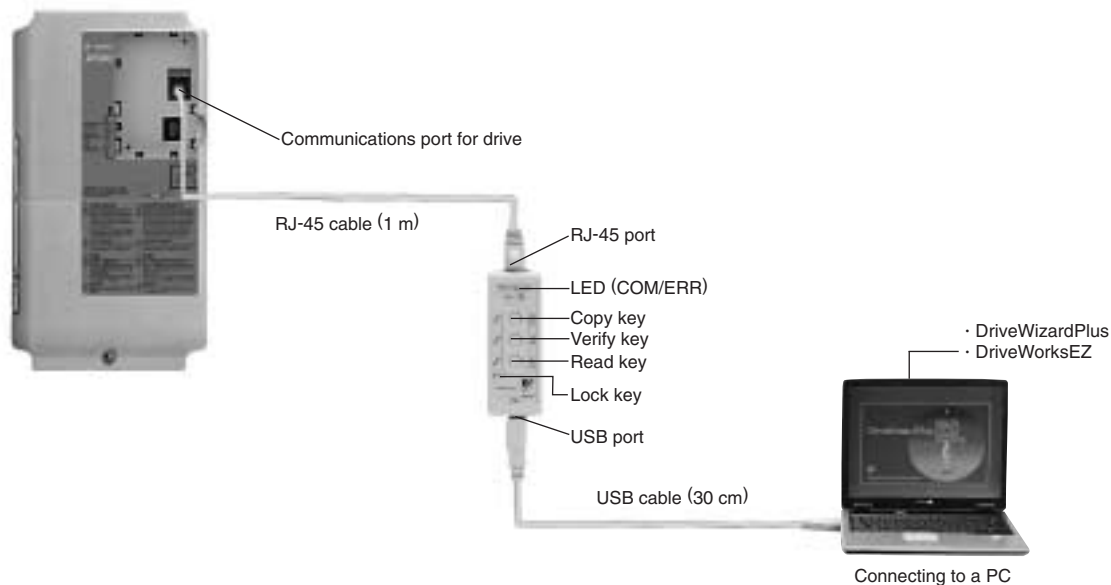

Note: No USB cable is needed to copy parameters to other drives.

Model	Code No.
JVOP-181	100-038-281

Note: JVOP-181 is a set consisting of a USB copy unit, RJ-45 cable, and USB cable.

### Specifications

Item	Specifications
Port	LAN (RJ-45)
	USB (Ver.2.0 compatible)
Power Supply	Supplied from a PC or the drive
Operating System	Windows2000/XP
Memory	Memorizes the parameters for one drive.
Dimensions	30 (W) × 80 (H) × 20 (D) mm
Accessories	RJ-45 Cable(1 m), USB Cable(30 cm)

Note: 1. Drives must have identical software versions to copy parameters settings.  
 2. Requires a USB driver.  
 3. Parameter copy function disabled when connected to a PC.

### Frequency Meter/Current Meter



Model	Code No.
Scale-75 Hz full-scale: DCF-6A	FM000065
Scale-60/120 Hz full-scale: DCF-6A	FM000085
Scale-5 A full-scale: DCF-6A	DCF-6A-5A
Scale-10 A full-scale: DCF-6A	DCF-6A-10A
Scale-20 A full-scale: DCF-6A	DCF-6A-20A
Scale-30 A full-scale: DCF-6A	DCF-6A-30A
Scale-50 A full-scale: DCF-6A	DCF-6A-50A

Note: DCF-6A specifications are 3 V, 1 mA, and 3 kΩ inner impedance. Because the A1000 multi-function analog monitor output default setting is 0 to 10 V, set frequency meter adjusting potentiometer (20 kΩ) or parameter H4-02 (analog monitor output gain) within the range of 0 to 3 V.

#### Dimensions (mm)

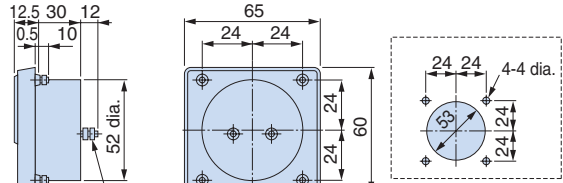

Terminal screw × 2 (M4)  
Mtg. bolt × 4 (M3)

Panel Cut-Out

Weight: 0.3 kg

### Variable Resistor Board (installed to drive terminals)



Model	Code No.
Meter scale 20 kΩ	ETX003120

#### Connection Diagram

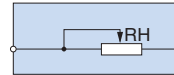

Weight: 20 g

### Frequency Setting Potentiometer/Frequency Meter Adjusting Potentiometer

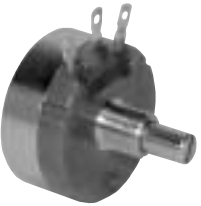

Model	Code No.
RV30YN20S 2 kΩ	RH000739
RV30YN20S 20 kΩ	RH000850

#### Dimensions (mm)

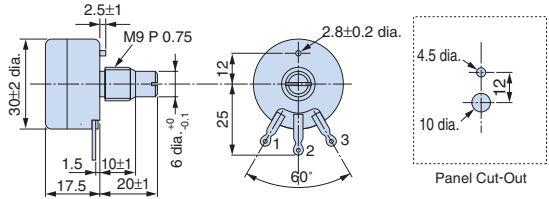

Weight: 0.2 kg

### Control Dial for Frequency Setting Potentiometer/Frequency Meter Adjusting Potentiometer



Model	Code No.
CM-3S	HLNZ-0036

#### Dimensions (mm)

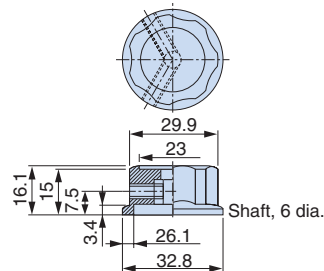

### Meter Plate for Frequency Setting Potentiometer/Frequency Meter Adjusting Potentiometer



Model	Code No.
NPJT41561-1	NPJT41561-1

#### Dimensions (mm)

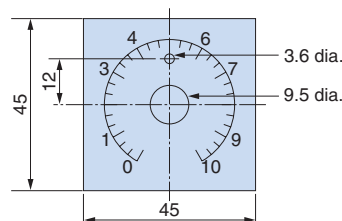



## ● Output Voltage Meter



Model	Code No.
Scale-300 V full-scale (Rectification Type Class 2.5: SCF-12NH)	VM000481
Scale-600 V full-scale (Rectification Type Class 2.5: SCF-12NH)	VM000502

### Dimensions (mm)

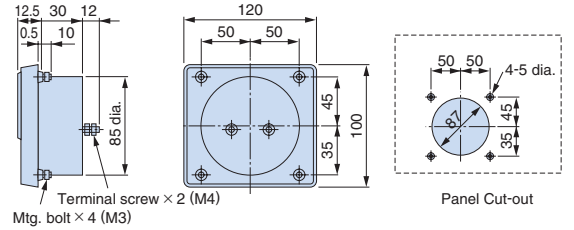

## ● Potential Transformer

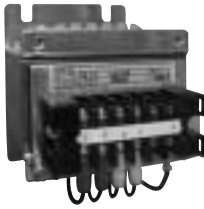

Model	Code No.
600 V meter for voltage transformer UPN-B 440/110 V (400/100 V)	100-011-486

Note: For use with a standard voltage regulator.  
A standard voltage regulator may not match the drive output voltage. Select a regulator specifically designed for the drive output (100-011-486), or a voltmeter that does not use a transformer and offers direct read out.

### Dimensions (mm)

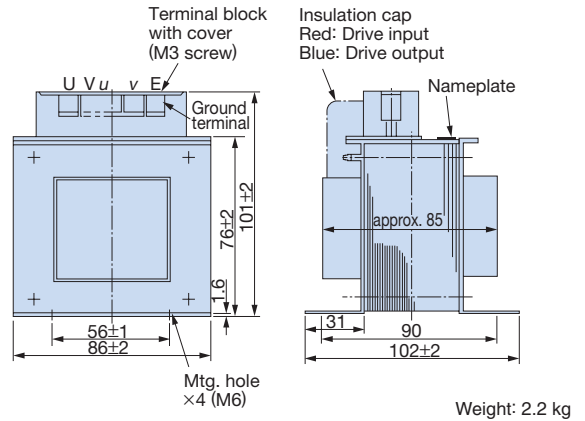

## Application Notes

### Selection

#### ■ Installing a Reactor

An AC or DC reactor can be used for the following situations:

- when the power supply is 600 kVA or more.
- to smooth peak current that results from switching a phase advance capacitor.
- to improve the power supply power factor.

A DC reactor comes standard with 200 V and 400 V class models with a capacity of 22 kW or more.

Be sure to use an AC reactor when the drive is using a power supply system with a thyristor converter.

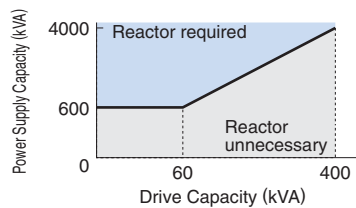

#### ■ Drive Capacity

When running a specialized motor or more than one motor in parallel from a single drive, the capacity of the drive should be larger than 1.1 times of the total motor rated current.

#### ■ Starting Torque

The overload rating for the drive determines the starting and accelerating characteristics of the motor. Expect lower torque than when running from line power. To get more starting torque, use a larger drive or increase both the motor and drive capacity.

#### ■ Emergency Stop

When the drive faults out, a protective circuit is activated and drive output is shut off. This, however, does not stop the motor immediately. Some type of mechanical brake may be needed if it is necessary to halt the motor faster than the Fast Stop function is able to.

#### ■ Options

The B1, B2, +1, and +2 terminals are used to connect optional devices. Connect only A1000-compatible devices.

#### ■ Repetitive Starting/Stopping

Cranes (hoists), elevators, punching presses, and other such applications with frequent starts and stops often exceed 150% of their rated current values. Heat stress generated from repetitive high current can shorten the lifespan of the IGBTs. The expected lifespan for the IGBTs is about 8 million start and stop cycles with a 2 kHz carrier frequency and a 150% peak current.

Yaskawa recommends lowering the carrier frequency, particularly when audible noise is not a concern. The

user can also choose to reduce the load, increase the acceleration and deceleration times, or switch to a larger drive. This will help keep peak current levels under 150%. Be sure to check the peak current levels when starting and stopping repeatedly during the initial test run, and make adjustments accordingly.

For cranes and other applications using the inching function in which the drives starts and stops the motor repeatedly, Yaskawa recommends the following steps to ensure torque levels:

- Select a large enough drive so that peak current levels remain below 150%.
- The drive should be one frame size larger than the motor.

### Installation

#### ■ Enclosure Panels

Keep the drive in a clean environment by either selecting an area free of airborne dust, lint, and oil mist, or install the drive in an enclosure panel. Leave the required space between the drives to provide for cooling, and take steps to ensure that the ambient temperature remains within allowable limits. Keep flammable materials away from the drive. If the drive must be used in an area where it is subjected to oil mist and excessive vibration, protective designs are available. Contact Yaskawa for details.

#### ■ Installation Direction

The drive should be installed upright as specified in the manual.

### Settings

#### ■ Use V/f Control when running multiple induction motors at the same time.

#### ■ If using Open Loop Vector Control designed for permanent magnet motors, make sure that the proper motor code has been set to parameter E5-01 before performing a trial run.

#### ■ Upper Limits

Because the drive is capable of running the motor at up to 400 Hz, be sure to set the upper limit for the frequency to control the maximum speed. The default setting for the maximum output frequency is 60 Hz.

#### ■ DC Injection Braking

Motor overheat can result if there is too much current used during DC Injection Braking, or if the time for DC Injection Braking is too long.



#### ■ Acceleration/Deceleration Times

Acceleration and deceleration times are affected by how much torque the motor generates, the load torque, and the inertia moment ( $GD^2/4$ ). Set a longer accel/decel time when Stall Prevention is enabled. The accel/decel times are lengthened for as long as the Stall Prevention function is operating. For faster acceleration and deceleration, increase the capacity of the drive.

### Compliance with Harmonic Suppression Guidelines

A1000 conforms to strict guidelines in Japan covering harmonic suppression for power conversion devices. Defined in JEM-TR201 and JEM-TR226 and published by the Japan Electrical Manufacturers' Association, these guidelines define the amount of harmonic current output acceptable for new installation. Refer to JEM-TR226 for more information on Japanese standards for harmonic suppression for power converters.

### General Handling

#### ■ Wiring Check

Never short the drive output terminals or apply voltage to output terminals (U/T1, V/T2, W/T3), as this can cause serious damage to the drive. Doing so will destroy the drive. Be sure to perform a final check of all sequence wiring and other connections before turning the power on. Make sure there are no short circuits on the control terminals (+V, AC, etc.), as this could damage the drive.

#### ■ Magnetic Contactor Installation

Avoid switching a magnetic contactor on the power supply side more frequently than once every 30 minutes. Frequent switching can cause damage to the drive.

#### ■ Inspection and Maintenance

After shutting off the drive, make sure the CHARGE light has gone out completely before performing any inspection or maintenance. Residual voltage in drive capacitors can cause serious electric shock.

The heatsink can become quite hot during operation, and proper precautions should be taken to prevent burns. When replacing the cooling fan, shut off the power and wait at least 15 minutes to be sure that the heatsink has cooled down.

#### ■ Wiring

Make sure to use ring tongue solderless terminals when wiring UL/cUL-certified drives. Use the tools recommended by the terminal manufacturer for caulking.

#### ■ Transporting the Drive

Never steam clean the drive.

During transport, keep the drive from coming into contact with salts, fluorine, bromine and other such harmful chemicals.

## ● Peripheral Devices

#### ■ Installing an MCCB

Install an MCCB or a ground fault interrupter recommended by Yaskawa to the power supply side of the drive to protect internal circuitry. The type of MCCB needed depends on the power supply power factor (power supply voltage, output frequency, load characteristics, etc.). Sometimes a fairly large MCCB may be required due to the affects of harmonic current on operating characteristics. Those using a ground fault interrupter other than those recommended in this catalog, use one fitted for harmonic suppression measures (one designed specifically for drives). The rated current of the ground fault interrupter must be 200 mA or higher per drive unit.

Select an MCCB or a ground fault interrupter with a rated capacity greater than the short-circuit current for the power supply. For a fairly large power supply transformer, a fuse can be added to the ground fault interrupter or MCCB in order to handle the short-circuit current level.

#### ■ Magnetic Contactor for Input Power

Use a magnetic contactor (MC) to ensure that power to the drive can be completely shut off when necessary. The MC should be wired so that it opens when a fault output terminal is triggered.

Even though an MC is designed to switch to a momentary power loss, frequent MC use can damage other components. Avoid switching the MC more than once every 30 minutes. The MC will not be activated after a momentary power loss if using the operator keypad to run the drive. This is because the drive is unable to restart automatically when set for LOCAL. Although the drive can be stopped by using an MC installed on the power supply side, the drive cannot stop the motor in a controlled fashion, and it will simply coast to stop. If a braking resistor or dynamic braking unit has been installed, be sure to set up a sequence that opens the MC with a thermal protector switch connected to the braking resistor device.

#### ■ Magnetic Contactor for Motor

As a general principle, the user should avoid opening and closing the magnetic contactor between the motor and the drive during run. Doing so can cause high peak currents and overcurrent faults. If magnetic contactors

are used to bypass the drive by connecting the motor to the power supply directly, make sure to close the bypass only after the drive is stopped and fully disconnected from the motor. The Speed Search function can be used to start a coasting motor.

Use an MC with delayed release if momentary power loss is a concern.

### Motor Thermal Over Load Relay Installation

Although the drive comes with built in electrothermal protection to prevent damage from overheat, a thermal relay should be connected between the drive and each motor if running several motors from the same drive. For a multipole motor or some other type of non-standard motor, Yasukawa recommends using an external thermal relay appropriate for the motor. Be sure to disable the motor protection selection parameter (L1-01 = 0), and set the thermal relay or thermal protection value to 1.1 times the motor rated current listed on the motor nameplate.

### Improving the Power Factor

Installing a DC or AC reactor to the input side of the drive can help improve the power factor.

Refrain from using a capacitor or surge absorber on the output side as a way of improving the power factor, because harmonic contents on the output side can lead to damage from overheat. This can also lead to problems with overcurrent.

### Radio Frequency Interference

Drive output contains harmonic contents that can affect the performance of surrounding electronic instruments such as an AM radio. These problems can be prevented by installing a noise filter, as well as by using a properly grounded metal conduit to separate wiring between the drive and motor.

### Wire Gauges and Wiring Distance

Motor torque can suffer as a result of voltage loss across a long cable running between the drive and motor, especially when there is low frequency output. Make sure that a large enough wire gauge is used.

The optional LCD operator requires a proprietary cable to connect to the drive. If an analog signal is used to operate the drive via the input terminals, make sure that the wire between the analog operator and the drive is no longer than 50 m, and that it is properly separated from the main circuit wiring. Use reinforced circuitry (main circuit and relay sequence circuitry) to prevent inductance from surrounding devices. To run the drive with a frequency potentiometer via the external terminals, use twisted shielded pair cables and ground the shield.

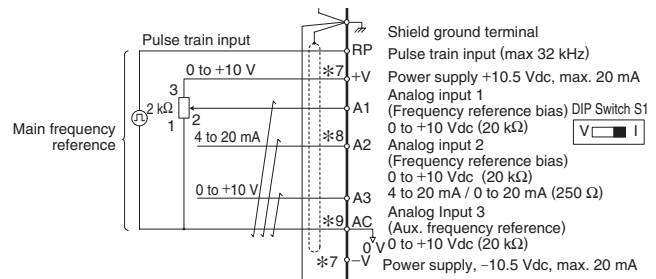

### Counteracting Noise

Because A1000 is designed with PWM control, a low carrier frequency tends to create more motor flux noise than using a higher carrier frequency. Keep the following points in mind when considering how to reduce motor noise:

- Lowering the carrier frequency minimizes the effects of noise.
- A line noise filter can reduce the affects on AM radio frequencies and poor sensor performance. See “Options and Peripheral Devices” on page 24.
- Make sure the distance between signal and power lines is at least 10 cm (up to 30 cm is preferable), and use twisted pair cable to prevent induction noise from the drive power lines.

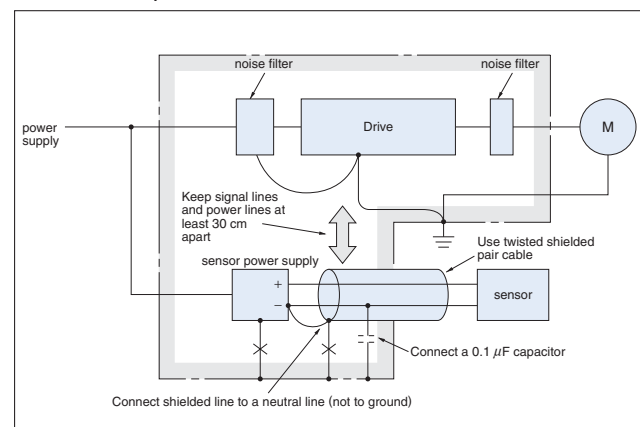

### Leakage Current

Harmonic leakage current passes through stray capacitance that exists between the power lines to the drive, ground, and the motor lines. Consider using the following peripheral devices to prevent problems with leakage current.

	Problem	Solution
Ground Leakage Current	MCCB is mistakenly triggered	<ul style="list-style-type: none"> <li>• Lower the carrier frequency set to parameter C6-02.</li> <li>• Try using a component designed to minimize harmonic distortion for the MCCB such as the NV series by Mitsubishi.</li> </ul>
Current Leakage Between Lines	Thermal relay connected to the external terminals is mistakenly triggered by harmonics in the leakage current	<ul style="list-style-type: none"> <li>• Lower the carrier frequency set to parameter C6-02.</li> <li>• Use the drive's built-in thermal motor protection function.</li> </ul>



### Setting the Carrier Frequency Relative to Wiring Distance

Wiring Distance	50 m or less	100 m or less	100 m or more
C6-02: Carrier Frequency Selection	1 to A (15 kHz or less)	1, 2, 7 to A (5 kHz or less)	1, 7 to A (2 kHz or less)

When running multiple motors from a single drive, remember that the motor cable length is determined as the total length of all motor cables combined.

Use V/f Control when motor wiring is longer than 100 m. Because V/f Control is not possible with a PM motor, be sure to keep motor wiring shorter than 100 m when using a PM motor.

Speed Search should be set for Current Detection Speed Search when running multiple motors.

## Notes on Motor Operation

### Using a Standard Motor

#### Low Speed Range

There is a greater amount of loss when operating a motor using an drive than when running directly from line power. With a drive, the motor can become quite hot due to the poor ability to cool the motor at low speeds. The load torque should be reduced accordingly at low speeds. The figure above shows the allowable load characteristics for a Yaskawa motor. A motor designed specifically for operation with a drive should be used when 100% continuous torque is needed at low speeds.

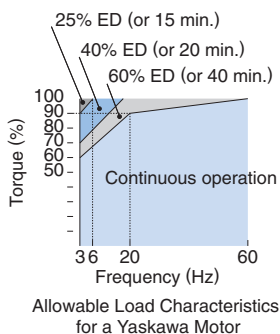

#### Insulation Tolerance

Consider voltage tolerance levels and insulation in applications with an input voltage of over 440 V or particularly long wiring distances. Contact Yaskawa for consultation.

#### High Speed Operation

Problems may occur with the motor bearings and dynamic balance in applications operating at over 60 Hz. Contact Yaskawa for consultation.

#### Torque Characteristics

Torque characteristics differ when operating directly from line power. The user should have a full understanding of the load torque characteristics for the application.

#### Vibration and Shock

A1000 lets the user choose between high carrier PWM control and low carrier PWM. Selecting high carrier PWM can help reduce motor oscillation. Keep the fol-

lowing points in mind when using high carrier PWM:

#### (1) Resonance

Take particular caution when using a variable speed drive for an application that is conventionally run from line power at a constant speed. Shock-absorbing rubber should be installed around the base of the motor and the Jump Frequency selection should be enabled to prevent resonance.

#### (2) Any imperfection on a rotating body increases vibration with speed.

Caution should be taken when operating above the motor rated speed.

#### (3) Subsynchronous Resonance

Subsynchronous resonance may occur in fans, blowers, turbines, and other applications with high load inertia, as well as in motors with a relatively long shaft. Yaskawa recommends using Closed Loop Vector Control for such applications.

#### Audible Noise

Noise created during run varies by the carrier frequency setting. Using a high carrier frequency creates about as much noise as running from line power. Operating above the rated speed (i.e., above 60 Hz), however, can create unpleasant motor noise.

### Using a Synchronous Motor

Please contact us for consultation when using a synchronous motor not already approved by Yaskawa.

For applications running a synchronous motor with the drive set for Heavy Duty performance (particularly hoists and conveyor applications), use Closed Loop Vector Control for PM (A1-02 = 7). Contact Yaskawa for details.

When the power to a drive running a PM motor is shut off, voltage continues to be generated at the motor terminals while the motor coasts to stop. Take the precautions described below to prevent shock and injury:

- Applications where the machine can still rotate even though the drive has fully stopped should have a load switch installed to the output side of the drive. Yaskawa recommends manual load switches from the AICUT LB Series by Aichi Electric Works Co., Ltd.
- Do not connect to a load that could potentially rotate the motor faster than the maximum allowable speed even when the drive has been shut off.
- Wait at least one minute after opening the load switch on the output side before inspecting the drive or performing any maintenance.
- Do not open and close the load switch while the motor

is running, as this can damage the drive.

- If the motor is coasting, make sure the power to the drive is turned on and the drive output has completely stopped before closing the load switch.
- Synchronous motors cannot be started directly from line power. Applications requiring line power to start should use an induction motor with the drive.
- A single drive is not capable of running multiple synchronous motors at the same time. Use a standard induction motor for such setups.
- At start, a synchronous motor may rotate slightly in the opposite direction of the Run command depending on parameter settings and motor type.
- The amount of starting torque that can be generated differs by the type of motor being used. Set up the motor with the drive after verifying the starting torque, allowable load characteristics, impact load tolerance, and speed control range.  
Contact Yaskawa if you plan to use a motor that does not fall within these specifications.
- Even with a braking resistor, braking torque is less than 125% when running between 20% to 100% speed, and falls to less than half the braking torque when running at less than 20% speed.
- The allowable load inertia moment is 50 times less than the motor inertia moment. Contact Yaskawa concerning applications with a larger inertia moment.
- When using a holding brake, release the brake prior to starting the motor. Failure to set the proper timing can result in speed loss. Conveyor, transport, and hoist applications using a holding brake should run an IPM motor in Closed Loop Vector Control for PM motors.
- To restart a coasting motor rotating at over 120 Hz, use the Short Circuit Braking\* function to first bring the motor to a stop. Short Circuit Braking requires a special braking resistor. Contact Yaskawa for details.  
Speed Search can be used to restart a coasting motor rotating slower than 120 Hz. If the motor cable is relatively long, however, the motor should instead be stopped using Short Circuit Braking and then restarted.

\* Short Circuit Braking creates a short-circuit in the motor windings to forcibly stop a coasting motor.

## ● Applications with Specialized Motors

### ■ Multi-Pole Motor

Because the rated current will differ from a standard motor, be sure to check the maximum current when selecting a drive. Always stop the motor before switching between the number of motor poles. If a regen overvoltage fault occurs or if overcurrent protection is triggered, the motor will coast to stop.

### ■ Submersible Motor

Because motor rated current is greater than a standard motor, select the drive capacity accordingly. Be sure to use a large enough motor cable to avoid decreasing the maximum torque level on account of voltage drop caused by a long motor cable.

### ■ Explosion-Proof Motor

Both the motor and drive need to be tested together to be certified as explosion-proof. The drive is not for explosion proof areas.

An explosion-proof pulse generators (PG) is used for an explosion-proof with voltage tolerance. Use a specially designed pulse coupler between the drive and the PG when wiring.

### ■ Geared Motor

Continuous operation specifications differ by the manufacturer of the lubricant. Due to potential problems of gear damage when operating at low speeds, be sure to select the proper lubricant. Consult with the manufacturer for applications that require speeds greater than the rated speed range of the motor or gear box.

### ■ Single-Phase Motor

Variable speed drives are not designed for operating single phase motors. Using a capacitor to start the motor causes excessive current to flow into the capacitors, potentially causing damage. A split-phase start or a repulsion start can end up burning out the starter coils because the internal centrifugal switch is not activated. A1000 is for use only with 3-phase motors.

### ■ Uras Vibrator

Uras vibrator is a vibration motor that gets power from centrifugal force by rotating unbalanced weights on both ends of the shaft. Make the following considerations when selecting a drive for use with an Uras vibrator:

- (1) Uras vibrator should be used within the drive rated frequency
- (2) Use V/f Control



- (3) Increase the acceleration time five to fifteen times longer than would normally be used due to the high amount of load inertia of an Uras vibrator

Note: Contact Yaskawa for applications that require an acceleration time of less than 5 s.

- (4) Drive may have trouble starting due to undertorque that results from erratic torque (static friction torque at start)

■ Motor with Brake

Caution should be taken when using a drive to operate a motor with a built-in holding brake. If the brake is connected to the output side of the drive, it may not release at start due to low voltage levels. A separate power supply should be installed for the motor brake. Motors with a built-in brake tend to generate a fair amount of noise when running at low speeds.

**Power Driven Machinery (decelerators, belts, chains, etc.)**

Continuous operation at low speeds wears on the lubricating material used in gear box type systems to accelerate and decelerate power driven machinery. Caution should also be taken when operating at speeds above the rated machine speed due to noise and shortened performance life.



# YASKAWA AC Drive Series



Name	Feature	Capacity Range (kW)		Outline	
		0.1	1 10 100 300 630		
General Purpose	J1000 Compact V/f Control AC Drive	Three-Phase 200 V Class	0.1  5.5	<ul style="list-style-type: none"> <li>Ultra-small body enables side-by-side installation. Compact design of enclosure panel</li> <li>Easy operation with the Potentiometer Option Unit</li> <li>The noise-suppressing Swing PWM system reduces harsh sound.</li> <li>The full-range fully-automatic torque boost function provides high torque output. (100%/1.5 Hz, 150%/3 Hz)</li> <li>The Stall Prevention function and the momentary power loss ride-thru ensure continuous operation, regardless of load/power supply fluctuations or momentary power loss.</li> <li>The Overexcitation braking function enables rapid braking, without using a braking resistor.</li> </ul>	
		Single-Phase 200 V Class	0.1  2.2		
		Three-Phase 400 V Class	0.2  5.5		
	V1000 Compact Vector Control AC Drive	Three-Phase 200 V Class	0.1  18.5		<ul style="list-style-type: none"> <li>Small body and high performance (Current vector control)</li> <li>New technology for driving synchronous motors (IPMM/SPMM) as well as induction motors</li> <li>High starting torque: 200%/0.5 Hz* Torque limit function * At Heavy Duty rating, for induction motors with 3.7 kW or lower</li> <li>Application-specific function selection for simplified optimum setup</li> <li>Easy maintenance using the detachable terminal block with the parameter backup function</li> </ul>
		Single-Phase 200 V Class	0.1  3.7		
		Three-Phase 400 V Class	0.2  18.5		
A1000 Advanced Vector Control AC Drive	Three-Phase 200 V Class	0.4  110	<ul style="list-style-type: none"> <li>New technology for driving synchronous motors (IPMM/SPMM) as well as induction motors</li> <li>High starting torque IPM motor without a motor encoder: 0 r/min 200% torque</li> <li>Application preset function selection for simplified optimum setup</li> <li>Easy maintenance using the detachable terminal block with the parameter backup function</li> </ul>		
	Three-Phase 400 V Class	0.4  630			
Varispeed F7 Advanced Current Vector Control General-purpose Inverter Minimal Noise	Three-Phase 200 V Class	0.4  110	<ul style="list-style-type: none"> <li>Open Loop Vector control ensures 150% or higher torque during operation at 0.5 Hz. Flux Vector Control provides high torque of 150% at zero speed.</li> <li>Easy maintenance and inspection using the detachable control circuit terminals and the detachable cooling fan</li> <li>PID control and energy-saving control</li> <li>The Auto-Tuning function upgrades all types of general motors to be compatible with high-performance drives.</li> </ul>		
	Three-Phase 400 V Class	0.4  300			
Varispeed G7 General-purpose Inverter With Advanced Vector Control Minimal Noise	Three-Phase 200 V Class	0.4  110	<ul style="list-style-type: none"> <li>The 400 V class uses 3-level control for a more perfect output waveform.</li> <li>Open Loop Vector control ensures 150% or higher torque during operation at 0.3 Hz. Flux Vector Control provides a high torque of 150% at zero speed.</li> <li>Easy maintenance and inspection using the detachable control circuit terminals and the detachable cooling fan.</li> <li>Software for various applications (for crane, hoist, etc.)</li> <li>The Auto-Tuning function upgrades all types of general motors to be compatible with high-performance drives.</li> </ul>		
	Three-Phase 400 V Class	0.4  300			
Varispeed AC Environmentally Friendly Motor Drives Matrix Converter	Three-Phase 200 V Class	5.5  45	<ul style="list-style-type: none"> <li>The world's first matrix converter system that outputs AC voltage from AC voltage, and includes power supply regeneration capabilities.</li> <li>The simple, highly-efficient drive can remarkably reduce power supply harmonics, without using peripherals.</li> </ul>		
	Three-Phase 400 V Class	5.5  75			
Varispeed F7S Super Energy-Saving Variable Speed Drive	Three-Phase 200 V Class	0.4  75	<ul style="list-style-type: none"> <li>Enables continuous operation of a synchronous motor (without PG) after momentary power loss, and startup of a coasting synchronous motor (without PG).</li> <li>Enables compact configuration of building air-conditioning system using LONWORKS.</li> </ul>		
	Three-Phase 400 V Class	0.4  300*			
Special Use	VS-626M5 VS-626MR5 VS-626MC5 Vector-controlled Inverter Drives With Power Regenerative Function For Machine Tools	Three-Phase 200 V Class	3.7  37	<ul style="list-style-type: none"> <li>For multiple-axis drive systems</li> <li>For machine tool spindle drives</li> <li>High-precision, quick-response, high-reliability AC drive system capable of using vector control to run a high-speed AC motor.</li> </ul>	
		Three-Phase 400 V Class	5.5  45		
		Three-Phase 200 V Class	3.7  37		
		Three-Phase 400 V Class	5.5  45		
	VS-646HF5 High-frequency Inverter Drives	Three-Phase 200 V Class	0.4  75	<ul style="list-style-type: none"> <li>For machine tool spindle drives</li> <li>Drive system capable of using vector control to run a high-speed AC motor.</li> </ul>	
		Three-Phase 400 V Class	0.4  75		

\* Maximum capacity without PG: 160 kW





# Global Service Network



Region	Service Area	Service Location	Service Agency	Telephone/Fax
North America	U.S.A.	Chicago (HQ) Los Angeles San Francisco New Jersey Boston Ohio North Carolina	① YASKAWA ELECTRIC AMERICA INC.	Headquarters ☎ +1-847-887-7000 FAX +1-847-887-7310
	Mexico	Mexico City	② PILLAR MEXICANA. S.A. DE C.V.	☎ +52-555-660-5553 FAX +52-555-651-5573
South America	South America	São Paulo	③ YASKAWA ELÉTRICO DO BRASIL LTD.A.	☎ +55-11-3585-1100 FAX +55-11-5581-8795
	Colombia	Bogota	④ VARIADORES LTD.A.	☎ +57-1-428-4225 FAX +57-1-428-2173
Europe	Europe, South Africa	Frankfurt	⑤ YASKAWA ELECTRIC EUROPE GmbH	☎ +49-6196-569-300 FAX +49-6196-569-398
			⑥ YASKAWA ENGINEERING EUROPE GmbH	☎ +49-6196-569-520 FAX +49-6196-888-598
Asia	Japan	Tokyo, offices nationwide	⑦ YASKAWA ELECTRIC CORPORATION (Manufacturing, sales)	☎ +81-3-5402-4502 FAX +81-3-5402-4580
			⑧ YASKAWA ELECTRIC ENGINEERING CORPORATION (After-sales service)	☎ +81-4-2931-1810 FAX +81-4-2931-1811
	South Korea	Seoul	⑨ YASKAWA ELECTRIC KOREA CORPORATION	☎ +82-2-784-7844 FAX +82-2-784-8495
			⑩ YASKAWA ENGINEERING KOREA Co.	☎ +82-2-3775-0337 FAX +82-2-3775-0338
	China	Beijing, Guangzhou, Shanghai	⑪ YASKAWA ELECTRIC (SHANGHAI) Co., Ltd.	☎ +86-21-5385-2200 FAX +86-21-5385-3299
	Taiwan	Taipei	⑫ YASKAWA ELECTRIC TAIWAN Co.	☎ +886-2-2502-5003 FAX +886-2-2505-1280
	Singapore	Singapore	⑬ YASKAWA ELECTRIC (SINGAPORE) Pte. Ltd.	☎ +65-6282-3003 FAX +65-6289-3003
			⑭ YASKAWA ENGINEERING ASIA-PACIFIC Pte. Ltd.	☎ +65-6282-1601 FAX +65-6282-3668
	Thailand	Bangkok	⑮ YASKAWA ELECTRIC (THAILAND) Co., Ltd.	☎ +66-2-693-2200 FAX +66-2-693-2204
	India	Mumbai	⑯ LARSEN & TOUBRO LIMITED	Headquarters ☎ +91-22-67226200 +91-22-27782230 FAX +91-22-27783032
Oceania	Australia	Sydney (HQ) Melbourne	⑰ ROBOTIC AUTOMATION Pty. Ltd.	Headquarters ☎ +61-2-9748-3788 FAX +61-2-9748-3817

# A1000

---

**DRIVE CENTER (INVERTER PLANT)**

2-13-1, Nishimiyaichi, Yukuhashi, Fukuoka, 824-8511, Japan  
Phone: 81-930-25-3844 Fax: 81-930-25-4369  
<http://www.yaskawa.co.jp>

**YASKAWA ELECTRIC CORPORATION**

New Pier Takeshiba South Tower, 1-16-1, Kaigan, Minatoku, Tokyo, 105-6891, Japan  
Phone: 81-3-5402-4502 Fax: 81-3-5402-4580  
<http://www.yaskawa.co.jp>

**YASKAWA AMERICA, INC.**

2121 Norman Drive South, Waukegan, IL 60085, U.S.A.  
Phone: (800) YASKAWA (927-5292) or 1-847-887-7000 Fax: 1-847-887-7310  
<http://www.yaskawa.com>

**YASKAWA ELÉTRICO DO BRASIL LTDA.**

Avenda Fagundes Filho, 620 Bairro Saude, São Paulo, SP04304-000, Brasil  
Phone: 55-11-3585-1100 Fax: 55-11-5581-8795  
<http://www.yaskawa.com.br>

**YASKAWA EUROPE GmbH**

Hauptstrasse 185, 65760 Eschborn, Germany  
Phone: 49-6196-569-300 Fax: 49-6196-569-398  
<http://www.yaskawa.eu.com>

**YASKAWA ELECTRIC UK LTD.**

1 Hunt Hill Orchardton Woods, Cumbernauld, G68 9LF, United Kingdom  
Phone: 44-1236-735000 Fax: 44-1236-458182  
<http://www.yaskawa.co.uk>

**YASKAWA ELECTRIC KOREA CORPORATION**

9F, Kyobo Securities Bldg., 26-4, Yeouido-dong, Yeongdeungpo-gu, Seoul, 150-737, Korea  
Phone: 82-2-784-7844 Fax: 82-2-784-8495  
<http://www.yaskawa.co.kr>

**YASKAWA ELECTRIC (SINGAPORE) PTE. LTD.**

151 Lorong Chuan, #04-01, New Tech Park, 556741, Singapore  
Phone: 65-6282-3003 Fax: 65-6289-3003  
<http://www.yaskawa.com.sg>

**YASKAWA ELECTRIC (SHANGHAI) CO., LTD.**

No.18 Xizang Zhong Road, 17F, Harbour Ring Plaza, Shanghai, 200001, China  
Phone: 86-21-5385-2200 Fax: 86-21-5385-3299  
<http://www.yaskawa.com.cn>

**YASKAWA ELECTRIC (SHANGHAI) CO., LTD. BEIJING OFFICE**

Room 1011, Tower W3 Oriental Plaza, No.1 East Chang An Ave.,  
Dong Cheng District, Beijing, 100738, China  
Phone: 86-10-8518-4086 Fax: 86-10-8518-4082

**YASKAWA ELECTRIC TAIWAN CORPORATION**

9F, 16, Nanking E. Rd., Sec. 3, Taipei, 104, Taiwan  
Phone: 886-2-2502-5003 Fax: 886-2-2505-1280



YASKAWA ELECTRIC CORPORATION

In the event that the end user of this product is to be the military and said product is to be employed in any weapons systems or the manufacture thereof, the export will fall under the relevant regulations as stipulated in the Foreign Exchange and Foreign Trade Regulations. Therefore, be sure to follow all procedures and submit all relevant documentation according to any and all rules, regulations and laws that may apply.

Specifications are subject to change without notice for ongoing product modifications and improvements.

© 2008-2011 YASKAWA ELECTRIC CORPORATION. All rights reserved.

LITERATURE NO. KAEP C710616 22G

Published in Japan June 2011 08-7 -0  
11-5-7